

# STAGO FIBRE-OPTIC DUCT SYSTEM CATALOGUE

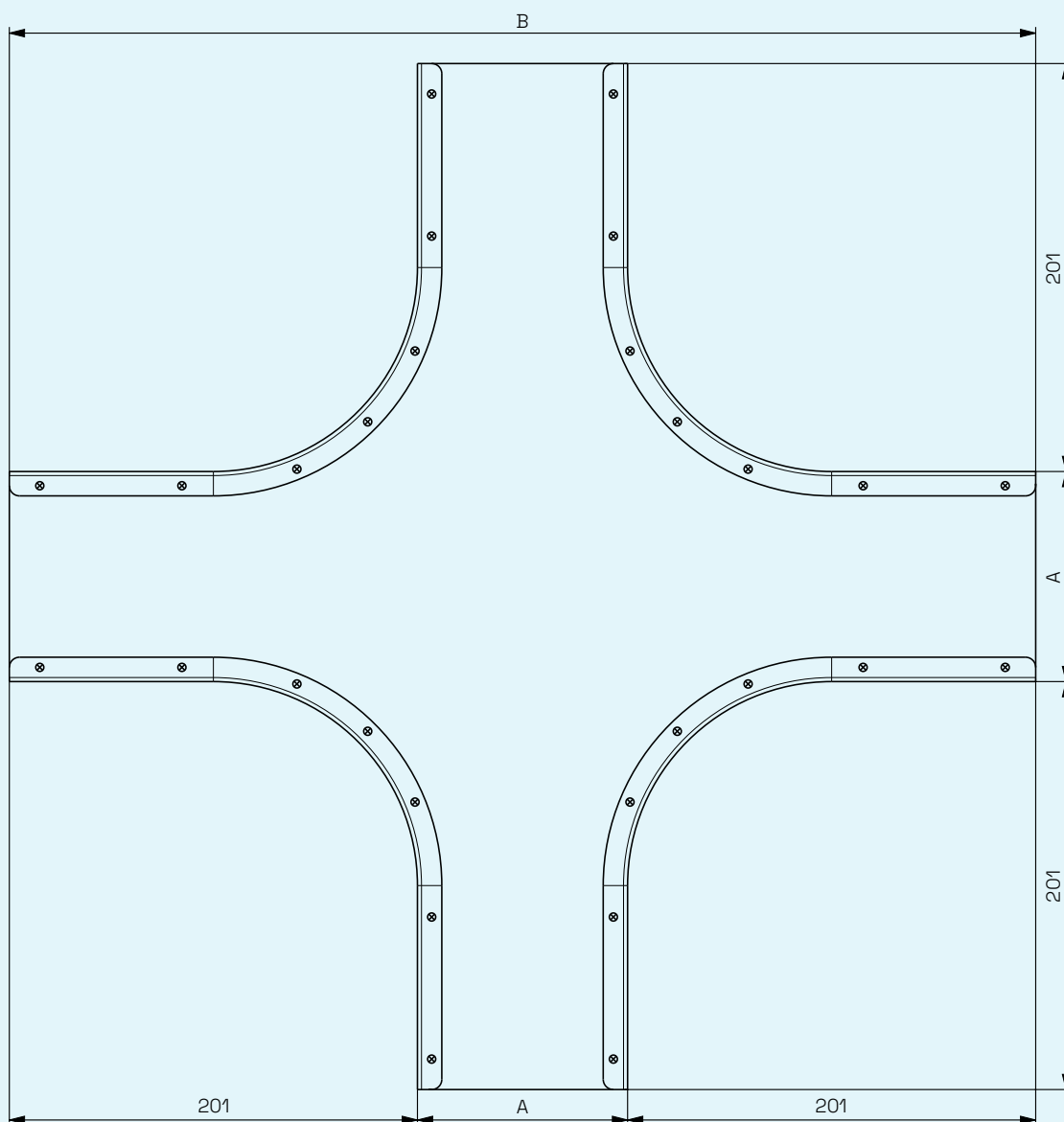



Creating clever, uplifting  
solutions, together with our  
clients for almost 100 years.  
Reimagined in June 2021  
– for the coming century.

Stago – the broadest metal cable tray range with the most  
clickable components providing a fast and efficient solution  
for a multitude of applications. Also well known for the  
innovate yellow fibre optic duct system.



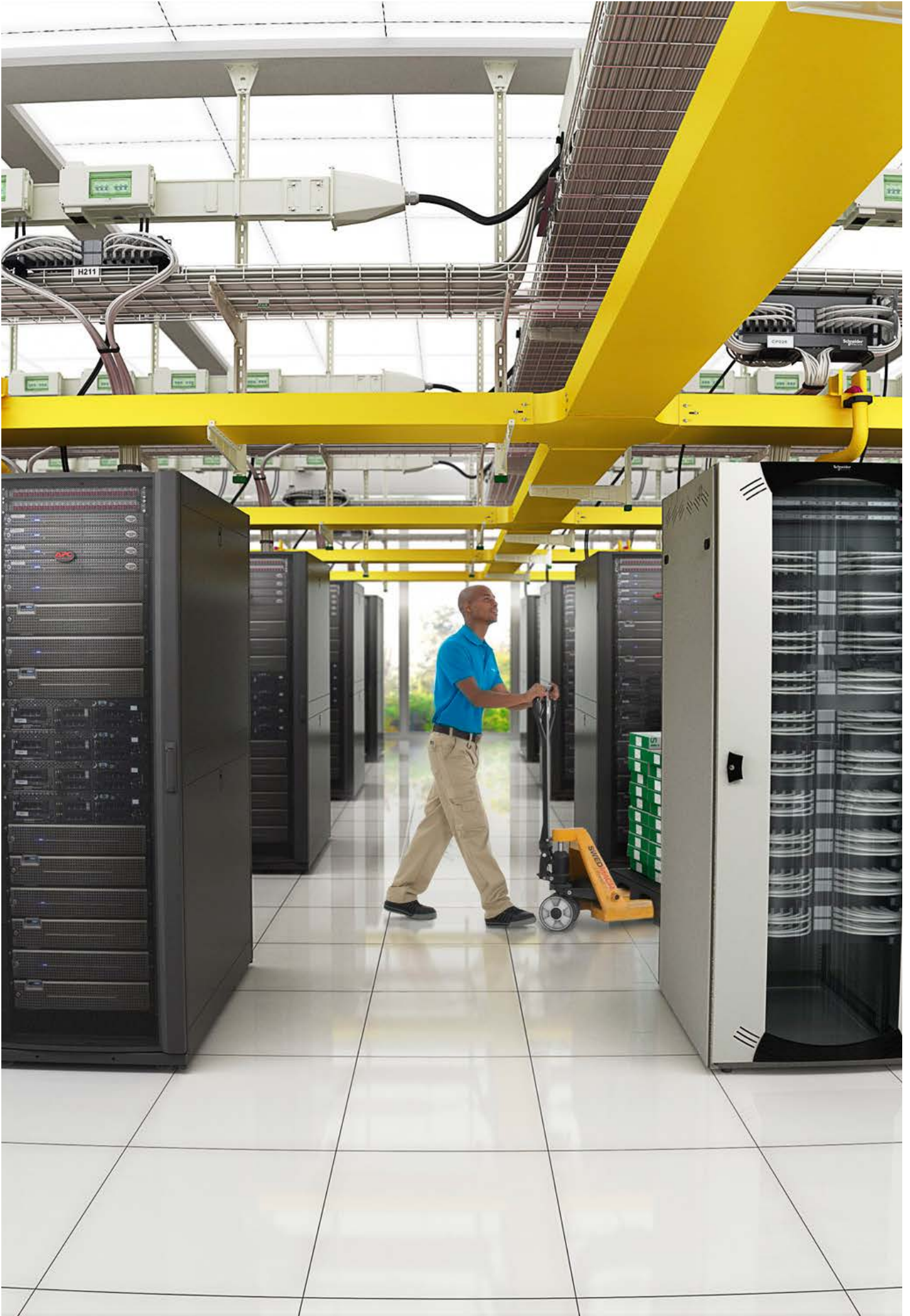

# General contents

---

Presentation 6

---

Mounting 12

---

Length material 14

---

Form piece 15

---

Modular accessory 19

---

Mounting accessory 21

---

Support system 23

---



P1501871

# Working together for full-scale effect of the infrastructure

## Network solutions

A large-scale Data Centre means large-scale cable management. Our wide range of fibre ducts and mesh trays provides flawless orderliness as well as easy adjustment and maintenance.

### **Stago Fibre-Optic Duct** – smooth, robust and versatile

In the Data Centre, rows and rows of smooth and robust fibre ducts provide safe and reliable distribution of sensitive cables. These sturdy steel ducts come with a wide range of accessories – bends, risers, junctions, reducers, and drop-offs. All designed to handle the most complex configurations, always with excellent protection of the cables.

### **Defem Mesh Tray** – flexible and lightweight

The mesh trays, with dedicated accessories and support systems, are excellent for the routing of huge amounts of copper-based data cables. Easily assembled with impressive capacity and long support distances, the mesh tray range reach from wide, heavy-duty versions to the flexible mini mesh, ideal for tricky installations in narrow spaces.



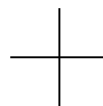

From here on this brochure presents the details. Because at the end of the day, it is the details that determine whether the Data Centre infrastructure will contribute to a successful life cycle – or if a coming infarct is a built-in mistake from birth.

## Power solutions

A reliable, efficient power supply system is the backbone of the Data Centre. As needs are in constant change, the power solution must be as reliable as it is flexible.

### **Wibe Ladders** – light, strong and dependable

As part of one of the most comprehensive cable support solutions on the market, Wibe cable ladders can be mounted in any direction or angle, distributing the cables safely and

efficiently throughout the building. Maintenance is carried out with little effort, in a work environment that provides both superb accessibility and overview.





# Stago Fibre-Optic Duct

## A dynamic and durable carrier

The “White space” is the heart of the Data Centre. The hub where millions of tiny fibre optic cables connect at the speed of light. Constantly On and evolving in pace with increasing demands, impersonating the term “living being”.

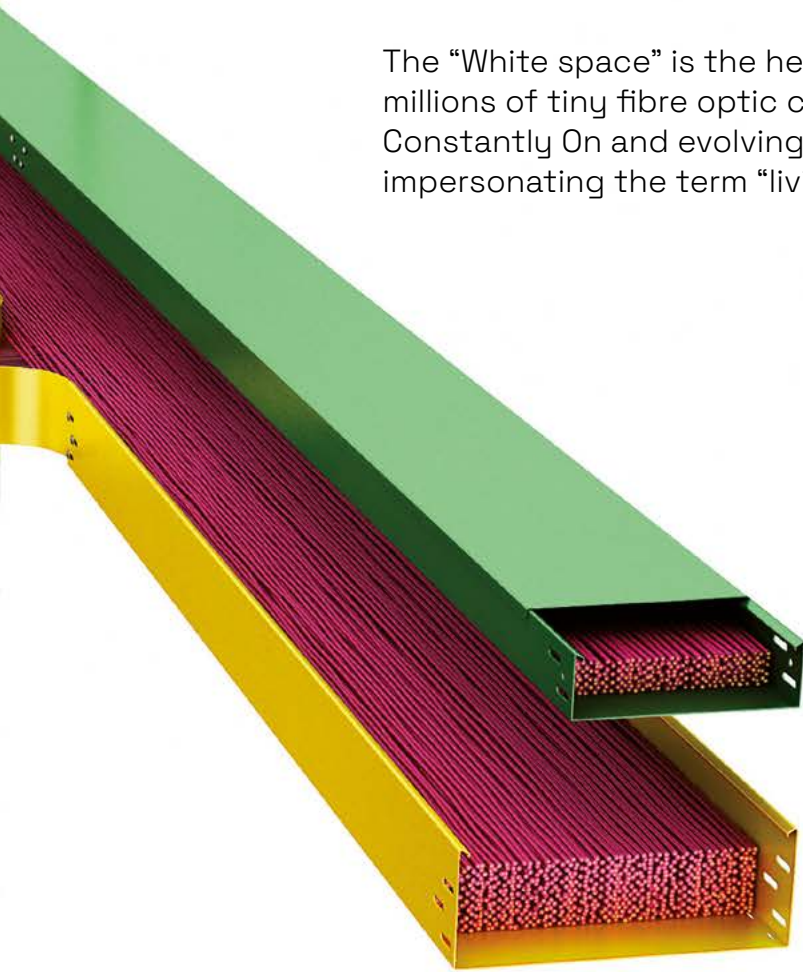

The Stago Fibre-Optic Ducts are the carriers of all heavy traffic in the Data Centre. Stable and strong, they are ready to perform. And once mounted, they will last and always be ready to evolve for new, unpredictable demands.

### The evolving system

Quick and easy to install, made for continuous development – always avoiding downtime. Swiftly adaptable to changing needs thanks to modular, tool-less accessories. A true “plug & play” concept.

### With efficiency in mind

A sturdy and robust steel system that allows long support distances without sagging, thus saving mounting time. And the consoles with one side open for cable management saves cabling and maintenance time. By suiting all ducts, ladders and busbars, the support system is both rational and economical.

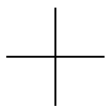
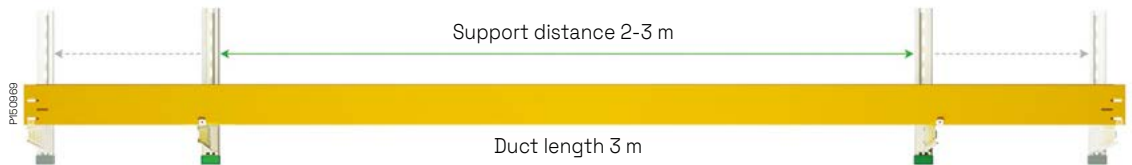

The Stago Fibre-Optic Duct is all metal and carries a higher load compared to non-metal systems. This means longer spans, minimised support, no sagging – and an overall more efficient and easily expandable installation.

### Ideal rail lengths

The 3-m duct is optimised for fast but non-heavy mounting. Add smart modular covers and support distances up to 3 m and you have a high-speed installation.

### Suitable dimensions

Stago FO ducts are available in heights of 60 or 110 mm, and widths of 100, 200, or 300 mm. All with the same smooth and soft shape.

### More than yellow

Standard colour of the ducting is yellow, RAL 1023. Other colours can be delivered on special order.

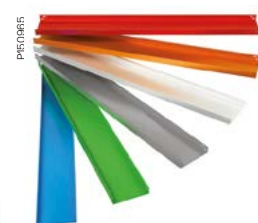
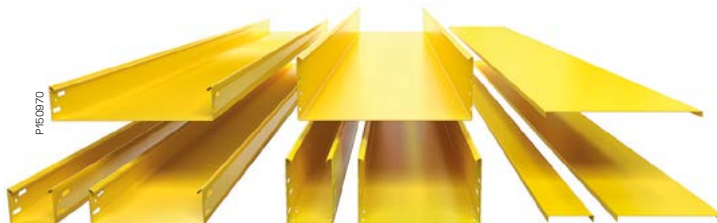

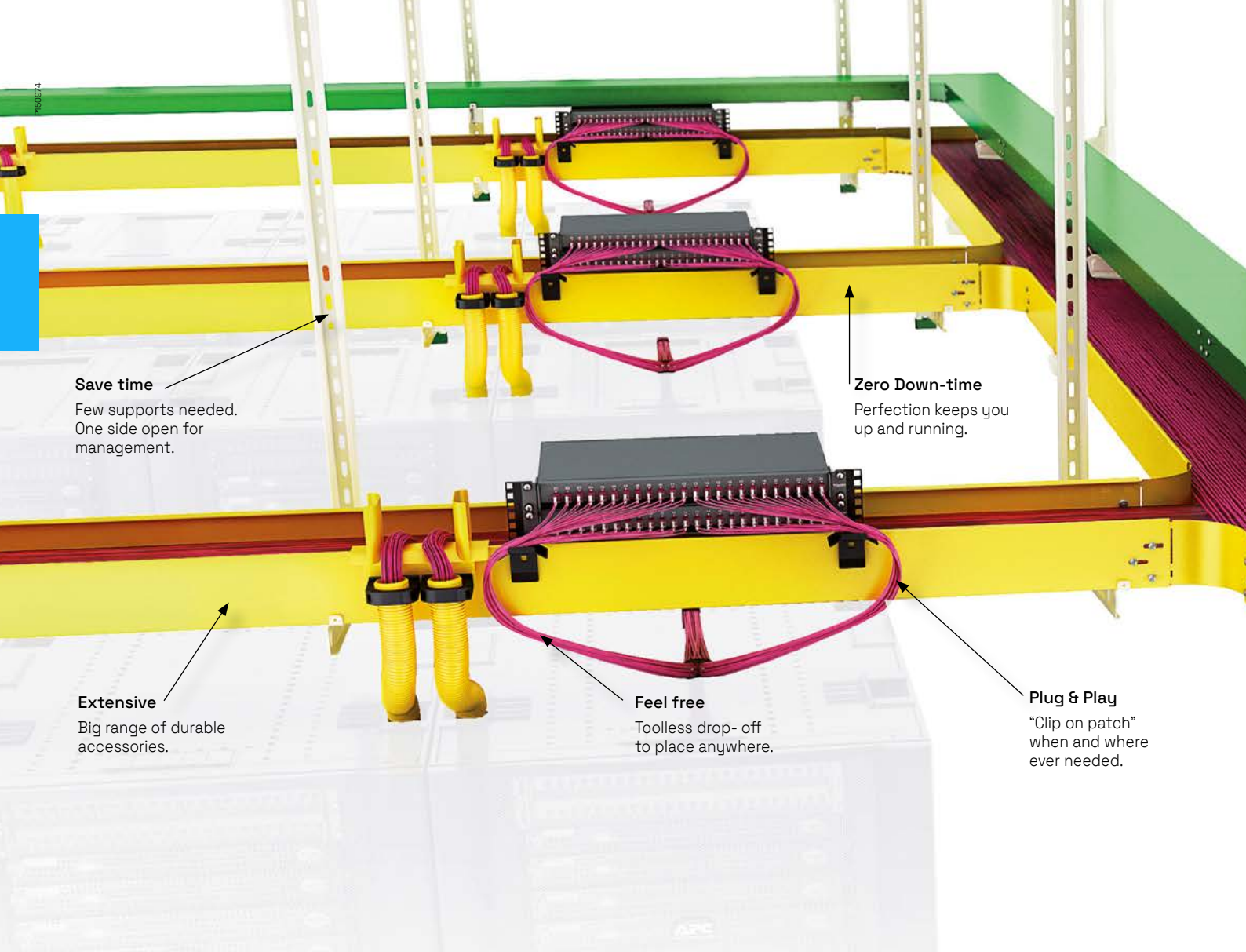

**Save time**

Few supports needed. One side open for management.

**Zero Down-time**

Perfection keeps you up and running.

**Extensive**

Big range of durable accessories.

**Feel free**

Toolless drop-off to place anywhere.

**Plug & Play**

"Clip on patch" when and where ever needed.

**Drop-off UDF**

Toolless installation – the UDFs ensure safe radius for the FO cables and can be moved sidwise to fit enclosure intake. Easily slid to meet new needs. Available in three sizes.

**Dividable tube**

The dividable tube provides a very neat and tidy solution for guiding the fibre and UTP down to the cabinet. Black colour is standard, yellow can be delivered on request.

**Modular covers**

Often the installation requires a cover. As there are different sizes of covers available, all types of installations can be fully covered with maintained accessibility.

**Optimised support system**

The single pendant support with robust consoles leaves one side open, allowing fast and easy cable management. Suits all types of cable support and busbars.

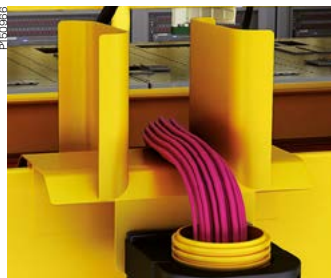



# Stago Fibre-Optic Duct High-performance management

It's crucial to carefully handle the fibre not to damage it or lose performance. But equally important is that the system is truly future-proof and competent enough to evolve smoothly and reliably.

Every component of the Stago FO Duct range is designed and developed with the same passionate care about both the fibre and the management. No matter how complex the configuration is, our ambition is that you do not have to worry about what is already installed, because it just works. Instead you can enjoy the easiness of further development of the plant to create new opportunities.

All in all, Stago FO Duct system is built to last and develop. Versatile, flexible and durable.

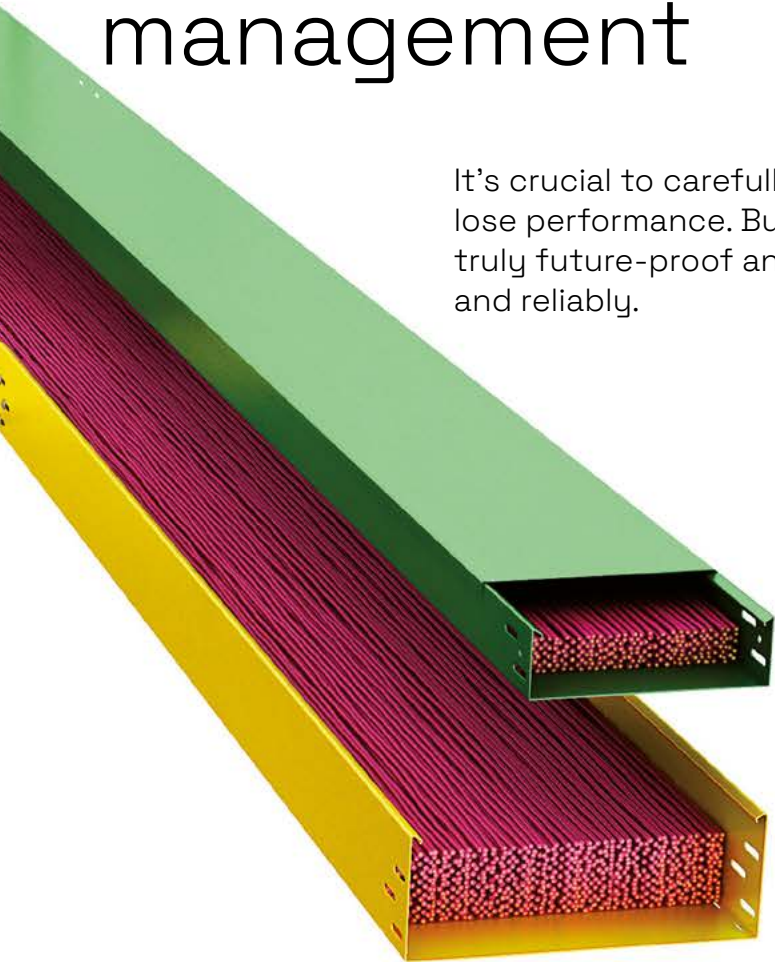

### Clip-on panel bracket

The tool-less patch panel attachment with clip-on-top significantly reduces down-time.



P150161

### Clip-on patch panel

Handy mini-patch. Six keystone footprints for UTP and FO. Space-saving and scalable.

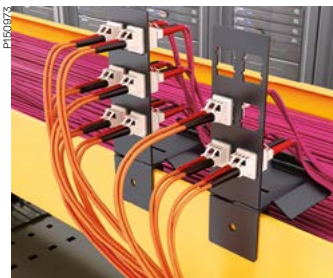

P150162

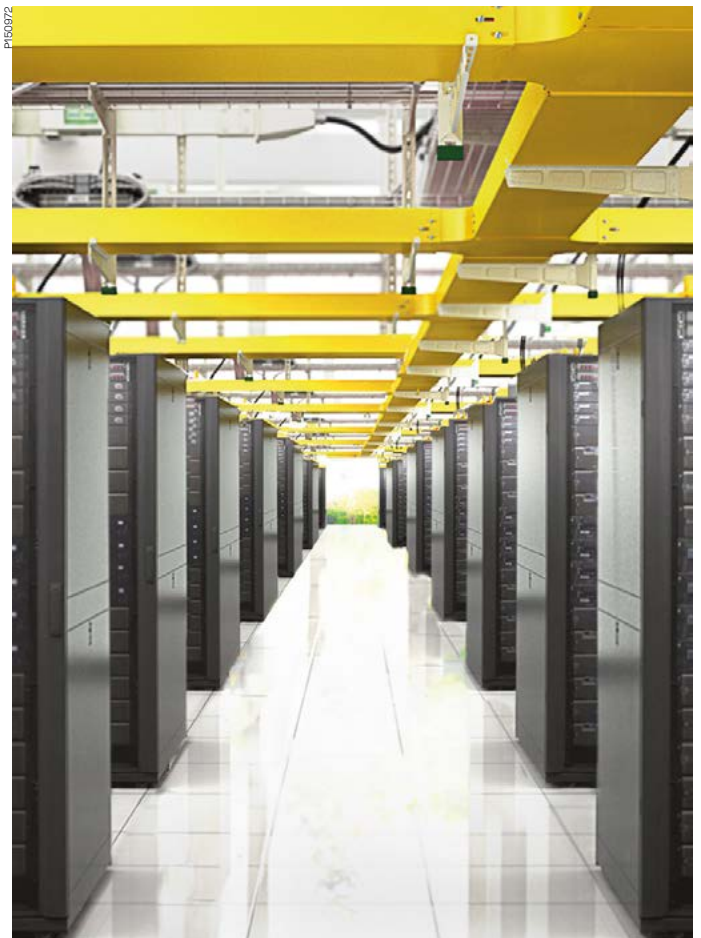

P150072



# Mounting

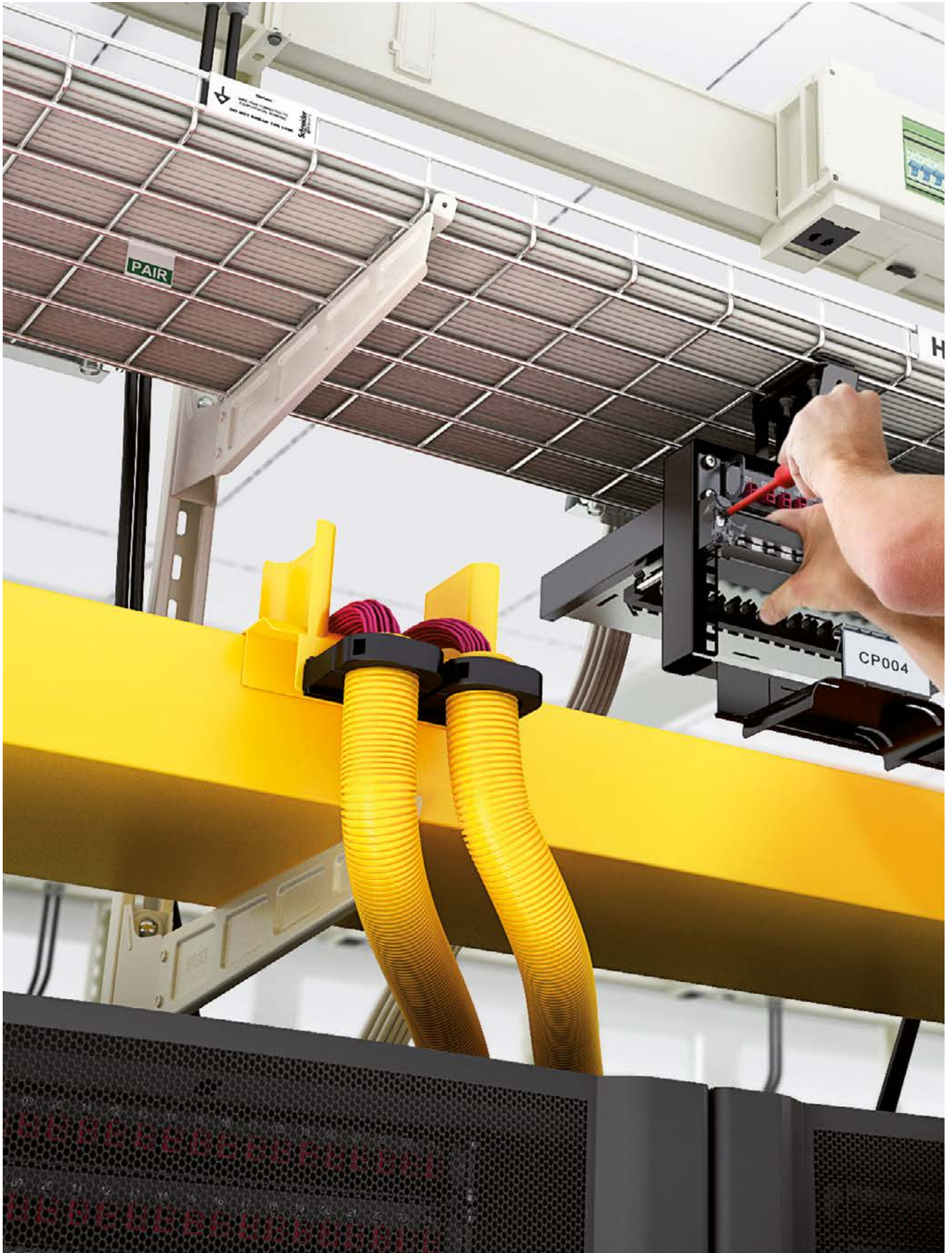



- |                     |                   |                             |                               |
|---------------------|-------------------|-----------------------------|-------------------------------|
| 1. Fibre-Optic Duct | 6. External riser | 11. Drop-off UDF            | 15. External coupler          |
| 2. Duct cover       | 7. 90° Bend       | 12. Patch panel bracket set | 16. Bolt set (M6)             |
| 3. Separation wall  | 8. T-piece        | 13. RJ45 bracket            | 17. Cover clamp               |
| 4. Branching piece  | 9. X-piece        | 14. Hinge coupler           | 18. Internal coupler (unlock) |
| 5. Internal riser   | 10. End piece     |                             |                               |

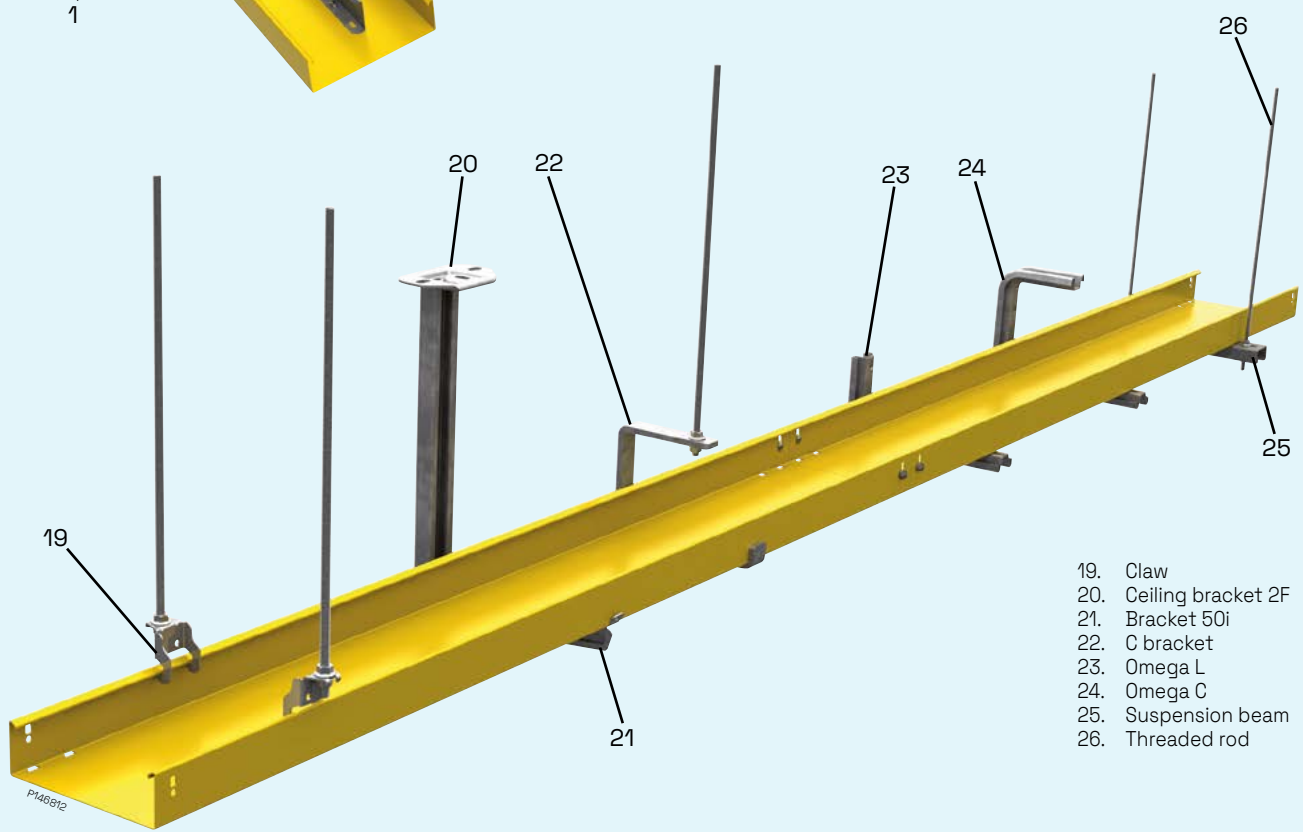
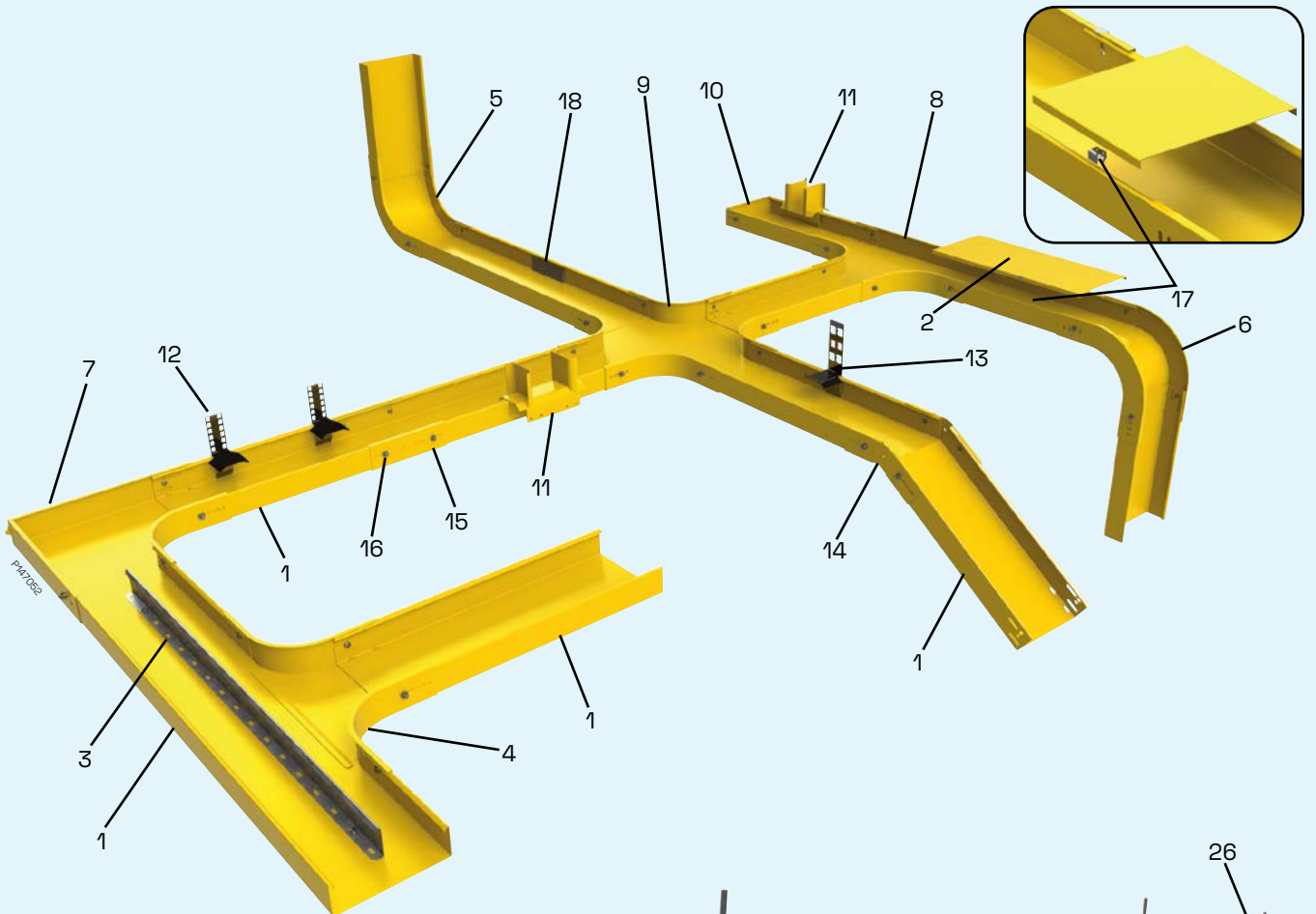

- |                        |
|------------------------|
| 19. Claw               |
| 20. Ceiling bracket 2F |
| 21. Bracket 50i        |
| 22. C bracket          |
| 23. Omega L            |
| 24. Omega C            |
| 25. Suspension beam    |
| 26. Threaded rod       |

## Length material

### Duct

Type	Dimensions Height x Width x Length (mm)				Weight (g)	Cat. no.
------	---	--	--	--	------------	----------

Metallic Fibre-Optic Duct for routing cables throughout the system. 3 meter length material ensures efficient system installation. Designed with rounded safety edges to protect cables. Connect individual lengths by using internal or external couplers and M6x16 bolts, nuts & star washers. Material: steel, pre-galvanized, powder coated RAL1023.

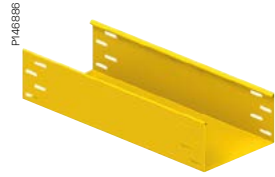

Height = 60 mm		H	W	L		
Fibre-Optic Duct	100	60	100	3000	5801	CSU7600104FS123
	200	60	200	3000	8228	CSU7600204FS123
	300	60	300	3000	10 655	CSU7600304FS123
Height = 110 mm		H	W	L		
Fibre-Optic Duct	100	110	100	3000	8228	CSU7100104FS123
	200	110	200	3000	10 655	CSU7100204FS123
	300	110	300	3000	13 082	CSU7100304FS123

### Duct cover

Type	Dimensions Height x Width x Length (mm)				Weight (g)	Cat. no.
------	---	--	--	--	------------	----------

Optional cover can be mounted for enhanced cable protection. Delivered in 2 m length. Snap-on fixation to the Fibre-Optic Duct by using universal cover clips (CSU08855000). Material: steel, pre-galvanized, powder coated RAL1023.



For height = 60 mm and 110 mm		H	W	L		
Duct cover	100	10	100	2000	1571	CSU0816113FS123
	200	10	200	2000	2875	CSU0816303FS123
	300	10	300	2000	5178	CSU0816433FS123

### Separation wall

Type	Dimensions Height x Width x Length (mm)				Weight (g)	Cat. no.
------	---	--	--	--	------------	----------

Optional separation wall to be able to create separate compartments in the Fibre-Optic Duct length material. Fix to the Fibre-Optic Duct by using M6x16 bolts, nuts & star washers. Material: steel, pre-galvanized.



Height = 60 mm		H	W	L		
Separation wall	55	20	3000	1473	CSU76020000	
Height = 110 mm		H	W	L		
Separation wall	105	20	3000	2382	CSU71020000	

# Form piece

## 90° bend

Type	Dimensions Height x Width x Length (mm)				Weight (g)	Cat. no.	
Can be used to construct horizontal 90° direction changes at any desired position in the fibre duct. Use M6x16 bolts, nuts & star washers to fix to the duct. Material: steel, pre-galvanized, powder coated RAL1023.							
	<b>Height = 60 mm</b>	<b>H</b>	<b>W</b>	<b>L</b>			
	90° bend	100	62	303	303	1036	CSU08616109FS123
		200	62	403	403	1637	CSU08616209FS123
		300	62	503	503	2328	CSU08616309FS123
	<b>Height = 110 mm</b>	<b>H</b>	<b>W</b>	<b>L</b>			
	90° bend	100	112	303	303	1472	CSU08611109FS123
200		112	403	403	2073	CSU08611209FS123	
300		112	503	503	2764	CSU08611309FS123	

## 90° bend cover

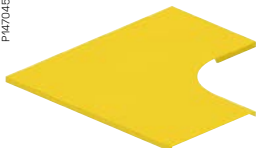
Type	Dimensions Height x Width x Length (mm)				Weight (g)	Cat. no.	
Optional 90° bend cover for enhanced cable protection. Snap-on fixation to the form piece by using universal cover clips (CSU08855000). Material: steel, pre-galvanized, powder coated RAL1023.							
	<b>For height = 60 mm and 110 mm</b>	<b>H</b>	<b>W</b>	<b>L</b>			
	90° bend cover	100	10	304	304	440	CSU08510109FS123
		200	10	404	404	797	CSU08510209FS123
		300	10	504	504	1254	CSU08510309FS123

## Adjustable corner piece

Type	Dimensions Height x Width x Length (mm)				Weight (g)	Cat. no.	
Can be used to construct variable horizontal bends in the fibre duct system. Use M6x16 bolts, nuts & star washers to fix to the duct. Material: steel, pre-galvanized, powder coated RAL1023.							
	<b>Height = 60 mm</b>	<b>H</b>	<b>W</b>	<b>L</b>			
	Adjustable corner piece	100	56	340	340	128	CSU08736109FS123
		200	56	440	440	500	CSU08736209FS123
		300	56	540	540	759	CSU08736309FS123
	<b>Height = 110 mm</b>	<b>H</b>	<b>W</b>	<b>L</b>			
	Adjustable corner piece	100	106	340	340	805	CSU08731109FS123
200		106	440	440	1258	CSU08731209FS123	
300		106	540	540	1700	CSU08731309FS123	

## Universal branching piece

Type	Dimensions Height x Width x Length (mm)				Weight (g)	Cat. no.	
Can be used to construct perpendicular branches at any desired position in the fibre duct. Use M6x16 bolts, nuts & star washers to fix to the duct. Material: steel, pre-galvanized, powder coated RAL1023.							
	<b>Height = 60 mm</b>	<b>H</b>	<b>W</b>	<b>L</b>			
	Universal branching piece	100	62	225	503	647	CSU08716109FS123
		200	62	225	603	774	CSU08716209FS123
		300	62	225	703	903	CSU08716309FS123
	<b>Height = 110 mm</b>	<b>H</b>	<b>W</b>	<b>L</b>			
	Universal branching piece	100	112	225	503	1016	CSU08711109FS123
200		112	225	603	1143	CSU08711209FS123	
300		112	225	703	1272	CSU08711309FS123	

## Universal branching piece cover

Type	Dimensions Height x Width x Length (mm)				Weight (g)	Cat. no.	
Optional branching piece cover for enhanced cable protection. Snap-on fixation to the form piece by using universal cover clips (CSU08855000). Material: steel, pre-galvanized, powder coated RAL1023.							
	<b>For height = 60 mm and 110 mm</b>	<b>H</b>	<b>W</b>	<b>L</b>			
	Universal branching piece cover	100	10	223	504	325	CSU08580109FS123
		200	10	223	604	399	CSU08580209FS123
		300	10	223	704	474	CSU08580309FS123

## Form piece (cont.)

### T-piece

Type	Dimensions	Height	Width	Length (mm)	Weight (g)	Cat. no.
------	------------	--------	-------	-------------	------------	----------

Can be used to construct horizontal T-intersections at any desired position in the fibre duct. Use M6x16 bolts, nuts & star washers to fix to the duct. Material: steel, pre-galvanized, powder coated RAL1023.



Height = 60 mm		H	W	L		
T-piece	100	62	301	504	1012	CSU08626109FS123
	200	62	401	604	1673	CSU08626209FS123
	300	62	501	704	2353	CSU08626309FS123
Height = 110 mm		H	W	L		
T-piece	100	112	301	504	1444	CSU08621109FS123
	200	112	401	604	2105	CSU08621209FS123
	300	112	501	704	2785	CSU08621309FS123

### T-piece cover

Type	Dimensions	Height	Width	Length (mm)	Weight (g)	Cat. no.
------	------------	--------	-------	-------------	------------	----------

Optional T-piece cover for enhanced cable protection. Snap-on fixation to the form piece by using universal cover clips (CSU08855000). Material: steel, pre-galvanized, powder coated RAL1023.



For height = 60 mm and 110 mm		H	W	L		
T-piece cover	100	10	305	504	641	CSU08520109FS123
	200	10	405	604	1049	CSU08520209FS123
	300	10	505	704	1547	CSU08520309FS123

### X-piece

Type	Dimensions	Height	Width	Length (mm)	Weight (g)	Cat. no.
------	------------	--------	-------	-------------	------------	----------

Can be used to construct horizontal cross intersections at any desired position in the fibre duct. Use M6x16 bolts, nuts & star washers to fix to the duct. Material: steel, pre-galvanized, powder coated RAL1023.



Height = 60 mm		H	W	L		
X-piece	100	62	504	504	1506	CSU08636109FS123
	200	62	604	604	2133	CSU08636209FS123
	300	62	704	704	2873	CSU08636309FS123
Height = 110 mm		H	W	L		
X-piece	100	112	504	504	2028	CSU08631109FS123
	200	112	604	604	2655	CSU08631209FS123
	300	112	704	704	3395	CSU08631309FS123

### X-piece cover

Type	Dimensions	Height	Width	Length (mm)	Weight (g)	Cat. no.
------	------------	--------	-------	-------------	------------	----------

Optional X-piece cover for enhanced cable protection. Snap-on fixation to the form piece by using universal cover clips (CSU08855000). Material: steel, pre-galvanized, powder coated RAL1023.



For height = 60 mm and 110 mm		H	W	L		
X-piece cover	100	10	504	504	975	CSU08530109FS123
	200	10	604	604	1300	CSU08530209FS123
	300	10	704	704	1802	CSU08530309FS123



## Form piece (cont.)

### Reducing cross piece

Type	Dimensions Height x Width x Length (mm)				Weight (g)	Cat. no.
------	---	--	--	--	------------	----------

Can be used to construct horizontal cross intersections between ducts of different widths at any desired position in the installation. Use M6x16 bolts, nuts & star washers to fix to the duct.  
Material: steel, pre-galvanized, powder coated RAL1023.



Height = 60 mm		H	W	L		
Reducing cross piece	300-100	62	505.5	705	2490	CSU0863610309FS123
	300-200	62	605.5	705	3050	CSU0863620309FS123
Height = 110 mm		H	W	L		
Reducing cross piece	300-100	112	505.5	705	3030	CSU0863110309FS123
	300-200	112	605.5	705	3590	CSU0863120309FS123

### Reducing cross piece cover

Type	Dimensions Height x Width x Length (mm)				Weight (g)	Cat. no.
------	---	--	--	--	------------	----------

Optional reducing X-piece cover for enhanced cable protection. Snap-on fixation to the form piece by using universal cover clips (CSU08855000).  
Material: steel, pre-galvanized, powder coated RAL1023.



For height = 60 mm and 110 mm		H	W	L		
Reducing cross piece cover	300-100	10	505.5	705	1662	CSU0853010309FS123
	300-200	10	605.5	705	2216	CSU0853020309FS123

### Internal riser

Type	Dimensions Height x Width x Length (mm)				Weight (g)	Cat. no.
------	---	--	--	--	------------	----------

Can be used to construct vertical 90° upwards direction changes at any desired position in the fibre duct. Use M6x16 bolts, nuts & star washers to fix to the duct.

Material: steel, pre-galvanized, powder coated RAL1023.

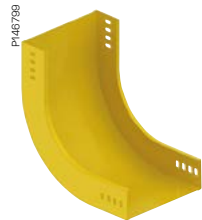

Height = 60 mm		H	W	L		
Internal riser	100	280	100	280	677	CSU08646109FS123
	200	280	200	280	1310	CSU08646209FS123
	300	280	300	280	1944	CSU08646309FS123
Height = 110 mm		H	W	L		
Internal riser	100	333	100	333	1207	CSU08641109FS123
	200	333	200	333	1841	CSU08641209FS123
	300	333	300	333	2475	CSU08641309FS123

### Internal riser cover

Type	Dimensions Height x Width x Length (mm)				Weight (g)	Cat. no.
------	---	--	--	--	------------	----------

Optional internal riser cover for enhanced cable protection. Snap-on fixation to the form piece by using universal cover clips (CSU08855000).  
Material: steel, pre-galvanized, powder coated RAL1023.



For height = 60 mm and 110 mm		H	W	L		
Internal riser cover	100	225	100	225	316	CSU08540109FS123
	200	225	200	225	632	CSU08540209FS123
	300	225	300	225	948	CSU08540309FS123

## Form piece (cont.)

### External riser

Type	Dimensions Height x Width x Length (mm)				Weight (g)	Cat. no.
------	---	--	--	--	------------	----------

Can be used to construct vertical 90° downwards direction change at any desired position in the fibre duct. Use M6x16 bolts, nuts & star washers to fix to the duct. Material: steel, pre-galvanized, powder coated RAL1023.

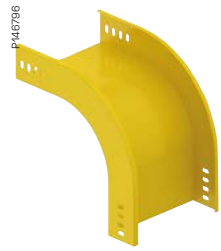

Height = 60 mm		H	W	L		
External riser	100	280	100	280	571	CSU08666109FS123
	200	280	200	280	1141	CSU08666209FS123
	300	280	300	280	1712	CSU08666309FS123
Height = 110 mm		H	W	L		
External riser	100	333	100	333	996	CSU08661109FS123
	200	333	200	333	1566	CSU08661209FS123
	300	333	300	333	2137	CSU08661309FS123

### External riser cover

Type	Dimensions Height x Width x Length (mm)				Weight (g)	Cat. no.
------	---	--	--	--	------------	----------

Optional external riser cover for enhanced cable protection. Snap-on fixation to the form piece by using universal cover clips (CSU08855000). Material: steel, pre-galvanized, powder coated RAL1023.



Height = 60 mm		H	W	L		
External riser cover	100	275	100	275	407	CSU08566109FS123
	200	275	200	275	807	CSU08566209FS123
	300	275	300	275	1211	CSU08566309FS123
Height = 110 mm		H	W	L		
External riser cover	100	334	100	334	496	CSU08561109FS123
	200	334	200	334	942	CSU08561209FS123
	300	334	300	334	1389	CSU08561309FS123

### Reducer piece

Type	Dimensions Height x Width x Length (mm)				Weight (g)	Cat. no.
------	---	--	--	--	------------	----------

Can be used to switch to any different duct size in width. Use M6x16 bolts, nuts & star washers to fix to the duct. Material: steel, pre-galvanized, powder coated RAL1023.



Height = 60 mm		H	W	L		
Reducer piece	200-100	60	205	288	730	CSU082610209FS123
	300-100	60	305	373	1090	CSU082610309FS123
	300-200	60	305	288	950	CSU082620309FS123
Height = 110 mm		H	W	L		
Reducer piece	200-100	110	205	288	950	CSU082110209FS123
	300-100	110	305	373	1390	CSU082110309FS123
	300-200	110	305	288	1170	CSU082120309FS123

### Reducer piece cover

Type	Dimensions Height x Width x Length (mm)				Weight (g)	Cat. no.
------	---	--	--	--	------------	----------

Optional reducer piece cover for enhanced cable protection. Snap-on fixation to the form piece by using universal cover clips (CSU08855000). Material: steel, pre-galvanized, powder coated RAL1023.



For height = 60 mm and 110 mm		H	W	L		
Reducer piece cover	200-100	11	205	288	380	CSU083010209FS123
	300-100	11	305	373	680	CSU083010309FS123
	300-200	11	305	288	610	CSU083020309FS123

### End piece

Type	Dimensions Height x Width x Length (mm)				Weight (g)	Cat. no.
------	---	--	--	--	------------	----------

End piece can be used to ensure an aesthetic finish to the ducting route. Use M6x16 bolts, nuts & star washers to fix to the duct. Material: steel, pre-galvanized, powder coated RAL1023.



Height = 60 mm		H	W	L		
End piece	100	10.5	64	230	95	CSU3618104FS123
	200	10.5	64	330	165	CSU3618204FS123
	300	10.5	64	430	223	CSU3618304FS123
Height = 110 mm		H	W	L		
End piece	100	10.5	114	230	247	CSU3118104FS123
	200	10.5	114	330	350	CSU3118204FS123
	300	10.5	114	430	452	CSU3118304FS123

# Modular accessory

## Modular drop-off UDF

Type	Dimensions Height x Width x Length (mm)			Weight (g)	Cat. no.
------	---	--	--	------------	----------

Clip-on modular drop-off can be fitted at any desired position on the lateral of the duct to ensure full flexibility in guiding fibre-optic cables from the duct to the racks / cabinets. Available in 3 different sizes.  
Material: steel, pre-galvanized, powder coated RAL1023.

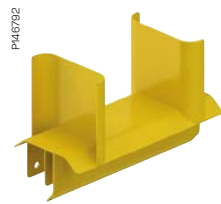

	H	W	L		
Drop-off UDF	50	115	90	150	565
	100	135	90	200	790
	250	135	90	345	1222

## Universal bobbin piece

Type	Dimensions Height x Width x Length (mm)			Weight (g)	Cat. no.
------	---	--	--	------------	----------

Magnetic bobbin piece can be fitted at any desired position of the duct or form piece for a secure and smooth guidance of fibre-optic cables. Use 2 pieces on bobbin to safely store cable over-length.  
Material: steel, pre-galvanized, powder coated RAL1023.



	H	W	L		
Bobbin piece	54	70	70	312	CSU0868A04FS123

## Patch panel bracket set

Type	Dimensions Height x Width x Length (mm)			Weight (g)	Cat. no.
------	---	--	--	------------	----------

Patch panel bracket set. To be used to mount any 19" patch panel at any desired position directly onto the duct. Simply clip-on the bracket to the lateral of the duct. Material: sheet steel, powder coated black.



	H	W	L		
Patch panel bracket 2U (set of 2 pieces)	151	74	84	533	CSU0829A01FS905

## RJ45 bracket

Type	Dimensions Height x Width x Length (mm)			Weight (g)	Cat. no.
------	---	--	--	------------	----------

RJ45 clip-on bracket can be placed on the lateral of the duct to construct mini consolidation points at any desired position. The universal design accepts both Actassi S-1 and Keystone footprints.  
Material: sheet steel, powder coated black.



	H	W	L		
6 Module RJ45 bracket	190	82	84	199	CSU0829A02FS905

## Closed tube

Type	Dimensions Ø (mm) x Length (mm)		Weight (g)	Cat. no.
------	---------------------------------	--	------------	----------

Optional closed extension tube for enhanced cable protection and flexible guidance of fibre-optic cables. To be mounted directly on the drop-off by using tube mounting frame (CSU0868A01FS905).



	Ø	L		
Closed tube	50	25 000	5625	CSU0868A03FS905

## Modular accessory (cont.)

### Openable tube

Type	Dimensions Ø (mm) x Length (mm)			Weight (g)	Cat. no.
------	---------------------------------	--	--	------------	----------

Optional divisible extension tube for enhanced cable protection and flexible guidance of fibre-optic cables. Openable tube for easy access for cable placement. To be mounted directly on the drop-off by using tube mounting frame (CSU0868A01FS905).



P147062

	Ø	L		
Openable tube	50	25 000	6575	CSU0868A02FS905

### Tube mounting frame

Type	Dimensions Height x Width x Length (mm)			Weight (g)	Cat. no.
------	---	--	--	------------	----------

Snap-in tube fixation to connect guiding tubes to drop-offs.



P147063

	H	W	L	
Tube mounting frame	20	68	67.5	260 CSU0868A01FS905

### Modular cover piece

Type	Dimensions Height x Width x Length (mm)			Weight (g)	Cat. no.
------	---	--	--	------------	----------

Modular cover piece can be fitted at any desired position on lengths to enhance cable protection at drop-out points. Snap-on fixation to the fibre duct by using universal cover clips (CSU08855000). Material: steel, pre-galvanized, powder coated RAL1023.



P147064

	H	W	L	
Modular cover piece	100	10	100	600 552 CSU0828103FS123
	200	10	200	600 1023 CSU0828203FS123
	300	10	300	600 1494 CSU0828303FS123

### Modular brush gasket

Type	Dimensions Height x Width x Length (mm)			Weight (g)	Cat. no.
------	---	--	--	------------	----------

Optional brush gasket for securing cover function at the position of clip-on accessories.



P148851

	H	W	L	
Modular brush gasket	100	10	400	145 NSYJPSVD

### Padlock adaptor

Type	Dimensions Height x Width x Length (mm)			Weight (g)	Cat. no.
------	---	--	--	------------	----------

Optional padlock adaptor for enhanced data protection. Use the adaptor with a padlock at any desired position in the fibre-duct to prevent easy access of fibre cables. Material: sheet steel, powder coated black.



P147065

	H	W	L	
Height = 60 mm	69.5	122	40	153 CSU7606100FS123
		222	40	229 CSU7606200FS123
		322	40	306 CSU7606300FS123
Height = 110 mm	110	122	40	200 CSU7106100FS123
		222	40	276 CSU7106200FS123
		322	40	353 CSU7106300FS123



# Mounting accessory

## External coupler

Type	Dimensions Height x Width x Length (mm)			Weight (g)	Cat. no.
External coupler system height 60 and 110 to be used to joint two lengths of Fibre-Optic Duct. Fixation with bolts M6x16, nuts & star washers. Use 2 couplers per duct. Material: steel, pre-galvanized, powder coated RAL1023.					
 <p>P148794</p>	<b>Height = 60 mm</b>	<b>H</b>	<b>W</b>	<b>L</b>	
	External coupler	60	10	200	129
	<b>Height = 110 mm</b>	<b>H</b>	<b>W</b>	<b>L</b>	
External coupler	110	10	200	200	CSU7105000FS123

## Internal coupler (Unilock)

Type	Dimensions Height x Width x Length (mm)			Weight (g)	Cat. no.
Screwless snap-in internal coupler for system height 60 to be used to joint two lengths of Fibre-optic duct. Optional fixation with bolts M6x16, nuts and star washers. Use 2 couplers per duct. Material: steel, pre-galvanized.					
 <p>P148807</p>	<b>Height = 60 mm</b>	<b>H</b>	<b>W</b>	<b>L</b>	
	Internal coupler (screwless)	21	55	175	82

## Internal coupler

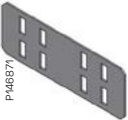
Type	Dimensions Height x Width x Length (mm)			Weight (g)	Cat. no.
Internal coupler for system height 110 to be used to joint two lengths of Fibre-Optic Duct. Fixation with bolts M6x16, nuts and star washers. Use 2 couplers per Duct. Material: steel, pre-galvanized.					
 <p>P148871</p>	<b>Height = 110 mm</b>	<b>H</b>	<b>W</b>	<b>L</b>	
	Internal coupler	1.5	106.5	300	365

## Hinge coupler

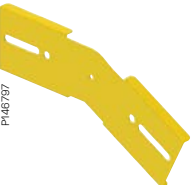
Type	Dimensions Height x Width x Length (mm)			Weight (g)	Cat. no.
Can be used to construct any type of level change at any point of the Fibre-Optic Duct installation. Use 2 couplers per Duct. To be used in combination with bolts M6x16, nuts and star washers. Material: steel, pre-galvanized, powder coated RAL1023.					
 <p>P148797</p>	<b>Height = 60 mm</b>	<b>H</b>	<b>W</b>	<b>L</b>	
	Hinge coupler	11	63	234	150
	<b>Height = 110 mm</b>	<b>H</b>	<b>W</b>	<b>L</b>	
Hinge coupler	12	114	230	406	CSU0875100FS123

## Bottom coupler

Type	Dimensions Height x Width x Length (mm)			Weight (g)	Cat. no.
Optional sleeve-on bottom coupler for enhanced system alignment. Material: steel, pre-galvanized, powder coated RAL1023.					
 <p>P148892</p>		<b>H</b>	<b>W</b>	<b>L</b>	
	Bottom coupler 200	1	100	170	130
		<b>H</b>	<b>W</b>	<b>L</b>	
Bottom coupler 300	1	100	270	209	CSU7070300FS123

## Bolt

Type	Dimensions Height x Width x Length (mm)			Weight (g)	Cat. no.
M6x16 bolts delivered in a bag of 100 pieces. Material: steel, electro-galvanized.					
 <p>P163497</p>		<b>H</b>	<b>W</b>	<b>L</b>	
	M6x16 bolt (pack of 100)	-	-	16	100

## Mounting accessory (cont.)

### Flange nut

Type	Weight (g)	Cat. no.
Flange nuts delivered in a bag of 100 pieces. Material: steel, electro-galvanized.		
	M6 flange nut (pack of 100)	311 CSU08461000
	M10 flange nut (pack of 100)	1200 CSU08890100

### Star washer

Type	Weight (g)	Cat. no.
Star washer to be used in combination with bolt (ref: CSU08463000) and M6 nut (ref: CSU08461000) to ensure electrical continuity throughout the system when connecting different system components. Ensure use of star washer on all painted surfaces. Delivered in a bag of 100 pieces. Material: steel, electro-galvanized.		
	M6 star washer (pack of 100)	323 CSU08190001

### Universal cover clip

Type	Dimensions Height x Width x Length (mm)	Weight (g)	Cat. no.
Universal cover clip for snap-on fixation of the covers. Delivered in a bag of 100 pieces. Material: spring steel.			
	H	W	L
	Universal cover clip (pack of 100)	15	13
		289	CSU08855000

### Modular cable retainer

Type	Dimensions Height x Width x Length (mm)	Weight (g)	Cat. no.
Suited with double sided self-adhesive tape to be fixed inside the duct. Delivered in 10 cm pieces in a bag of 50.			
	H	W	L
	Modular cable retainer (pack of 50)	5.5	25
		8	718469

### Protection strip

Type	Dimensions Height x Width x Length (mm)	Weight (g)	Cat. no.
Protection strip. To be used to protect cutted edges in the cable duct. Delivered as roll of 5 m. Material: PVC, black.			
	H	W	L
	Protection strip	-	-
		342	CSU08040000

### Earthing kit

Type	Dimensions Height x Width x Length (mm)	Weight (g)	Cat. no.
Kit including earth wire with flat pin connectors and earthing clamps. Connect to 2 cover pieces to ensure electrical continuity between each other. Delivered in a bag of 10 pieces.			
	H	W	L
	Earthing kit (Pack of 10)	-	-
		10	ISM10953

# Support system

## Cantilever arm 50i

Type	Dimensions Height x Width x Length (mm)				Weight (g)	Cat. no.
------	---	--	--	--	------------	----------

Medium duty cantilever arm 50i for direct wall installation or ceiling suspended installation in combination with pendant fixing rail 24/48 and T-bolt. Use bolts M6x16, nuts and star washers to fix fibre-optic duct to the bracket. Material: steel, pre-galvanized.



		H	W	L		
Cantilever arm 50i	100	80	43	159	190	791412
	200	85	43	259	290	791413
	300	110	43	359	460	791414

## C-bracket

Type	Dimensions Height x Width x Length (mm)				Weight (g)	Cat. no.
------	---	--	--	--	------------	----------

C-bracket for single central suspended threaded rod installation. Use bolts M6x16, nuts and star washers to fix fibre-optic duct to the bracket. Material: steel, pre-galvanized.

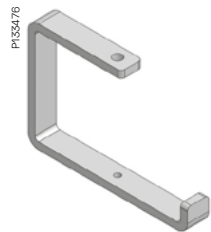

		H	W	L		
C-bracket	100	35	110	150	380	CSU08173109
	200	45	150	215	940	CSU08173209
	300	175	240	340	1530	CSU08173309

## Omega C-bracket

Type	Dimensions Height x Width x Length (mm)				Weight (g)	Cat. no.
------	---	--	--	--	------------	----------

Omega C-bracket for direct ceiling installation. Use bolts M6x16, nuts and star washers to fix fibre-optic duct to the bracket. Material: steel, pre-galvanized.



		H	W	L		
Omega C-bracket	100	196	50	153	516	4550410
	200	196	50	252	631	4550420
	300	196	50	357	769	4550430

## Omega L-bracket

Type	Dimensions Height x Width x Length (mm)				Weight (g)	Cat. no.
------	---	--	--	--	------------	----------

Light duty Omega L-bracket for direct wall installation. Use bolts M6x16, nuts and star washers to fix fibre-optic duct to the bracket. Material: steel, pre-galvanized.



		H	W	L		
Omega L-bracket	100	131	50	150	323	4550310
	200	131	50	250	450	4550320
	300	131	50	350	575	4550330

## Suspension beam

Type	Dimensions Height x Width x Length (mm)				Weight (g)	Cat. no.
------	---	--	--	--	------------	----------

Suspension beam for double-threaded rod suspended installation. Use bolts M6x16, nuts and star washers to fix fibre-optic duct to the beam. Material: steel, pre-galvanized.



		H	W	L		
Suspension beam	100	30	40	160	202	CSU08041000
	200	30	40	260	358	CSU08043000
	300	30	40	360	606	CSU08044500

## Support system (cont.)

### Claw

Type	Dimensions Height x Width x Length (mm)			Weight (g)	Cat. no.
------	---	--	--	------------	----------

Can be used for light double threaded rod installations.  
Material: steel, pre-galvanized.

P416800



	H	W	L		
Claw	46	58	46	49	CSU08150209

### Ceiling bracket

Type	Dimensions Height x Width x Length (mm)			Weight (g)	Cat. no.
------	---	--	--	------------	----------

Ceiling bracket 5 with fixing rail 24/48 to construct a pendant system. Bolts and nuts not included.  
Material: steel, pre-galvanized

P359601



	H	W	L		
Ceiling bracket 5	40	100	135	350	721101

### Vertical pieces

Type	Dimensions Height x Width x Length (mm)			Weight (g)	Cat. no.
------	---	--	--	------------	----------

Length of the pendant can be extended by using pendant fixing rail 24/48 and rail connector 2FJ.  
Material: steel, hot-dip galvanized.

P416867



	H	W	L			
Vertical pieces 2F	280	80	135	280	800	717196
	370	80	135	370	980	717197
	505	80	135	505	1260	717198
	730	80	135	730	1710	717199
	1000	80	135	1000	2250	717200
	1500	80	135	1491	2900	787276

### Pendant / Fixing rail

Type	Dimensions Height x Width x Length (mm)			Weight (g)	Cat. no.
------	---	--	--	------------	----------

Pendant / Fixing rail for mounting of cantilever arms. Can be suspended from ceiling to ceiling bracket 5 or installed to the wall directly.  
Material: steel, pre-galvanized.

P359410



	H	W	L		
Pendant / Fixing rail 24/48	26	48	5940	11 200	731721

### Rail connector

Type	Dimensions Height x Width x Length (mm)			Weight (g)	Cat. no.
------	---	--	--	------------	----------

Rail connector for extending pendant / fixing rails and vertical piece pendants.  
Material: steel, pre-galvanized.

P359600



	H	W	L		
Rail connector 2FJ	54	15	200	460	CSU795325

## Support system (cont.)

### Threaded rod M10

Type	Dimensions Ø (mm) x Length (mm)			Weight (g)	Cat. no.
M10 threaded rod for suspended installations. Material: steel, electro-galvanized.					
 Threaded rod	Ø	L			
	10	2000		1000	CSU08050000
	10	3000		1500	CSU08050100

### Threaded rod extension M10

Type	Dimensions Ø (mm) x Length (mm)			Weight (g)	Cat. no.
Use threaded rod extension to extend threaded rod length if needed. Material: steel, electro-galvanized.					
 Threaded rod extension	Ø	L			
	12	50		25	CSU08920000

### End plug

Type	Dimensions Height x Width x Length (mm)			Weight (g)	Cat. no.
High visibility end plug for enhanced safety and easy identification. Material: PP/TPE, orange					
 End Plug 28E	H	W	L		
	30	24	52	8	709021

### T-bolt M8

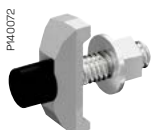
Type	Dimensions Height x Width x Length (mm)			Weight (g)	Cat. no.
T-bolt to be used for mounting cantilever arms onto Pendant / Fixing rail 24/48 or vertical piece 2F. Material: steel, hot-dip galvanized.					
 T-bolt 26F	H	W	L		
	8	43	50	45	734983

### Draco electric metal shear cutter

Type	Dimensions Height x Width x Length (mm)			Weight (g)	Cat. no.
Use electric shear to ensure a fast, safe and clean cut of fibre duct length material.					
 Draco electric metal shear cutter	H	W	L		
	210	90	410	2700	CSU08770200

### Draco electric shear cutter knife

Type	Dimensions Height x Width x Length (mm)			Weight (g)	Cat. no.
Replacement knife for Draco electric metal shear cutter.					
 Draco electric shear cutter knife	H	W	L		
	120	12	200	68	CSU08780200



# Stago Fibre-Optic Duct

## Standards

IEC 61537 specifies requirements and tests for cable tray, cable ladder and cable ducting systems intended for the support and accommodation of cables and possibly other electrical equipment in electrical and/or communication systems installation.

The standard EN 61537 establishes that for Cable Ducts with electrical continuity characteristics (metal), this continuity should be guaranteed by means of an equipotential connection and one or several connections to earth in accordance with the use of the Cable Duct system.

To guarantee a safe installation, Wibe Group recommends a proper earthing of all elements that make up the system (section and accessories), using the accessories designed specifically for this purpose.

## Cable filling capacity

The figures in the table below are calculated considering a 50 % cable loading factor.

Dimensions Height x Width (mm)	Cable filling capacity (load factor of 50 %) Optical fibre			
	Ø 1.2 mm	Ø 1.6 mm	Ø 2 mm	Ø 3 mm
60 x 100	1653	1413	905	402
60 x 200	4218	2856	1828	812
60 x 300	6782	4298	2751	1223
110 x 100	3820	2632	1684	749
110 x 200	8594	5318	3403	1513
110 x 300	13369	8004	5122	2277

## Working loads and span recommendations

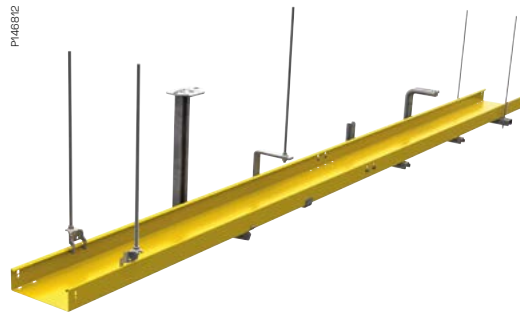

Support width (mm)	Supports SWL (kg)				
	Pendant 2F + Cantilever 50i	C-bracket	Omega wall bracket	Omega ceiling bracket	Suspension beam
100	230.2	20.9	198	123	200
200	160.4	72.6	100	90	200
300	123.1	75.6	78	75	200

Criteria:	Max. recommended span, considering FO cables	Supports SWL (kg)				
		Pendant 2F + Cantilever 50i	C-bracket	Omega wall bracket	Omega ceiling bracket	Suspension beam
MIN of MPL/SWL	60 x 100	3	3	3	3	3
	60 x 200	3	3	3	3	3
	60 x 300	3	3	3	3	3
	110 x 100	3	3	3	3	3
	110 x 200	3	3	3	3	3
	110 x 300	3	3	3	3	3



