

MITA[®] GRP CABLE SUPPORT SOLUTIONS

For rail applications

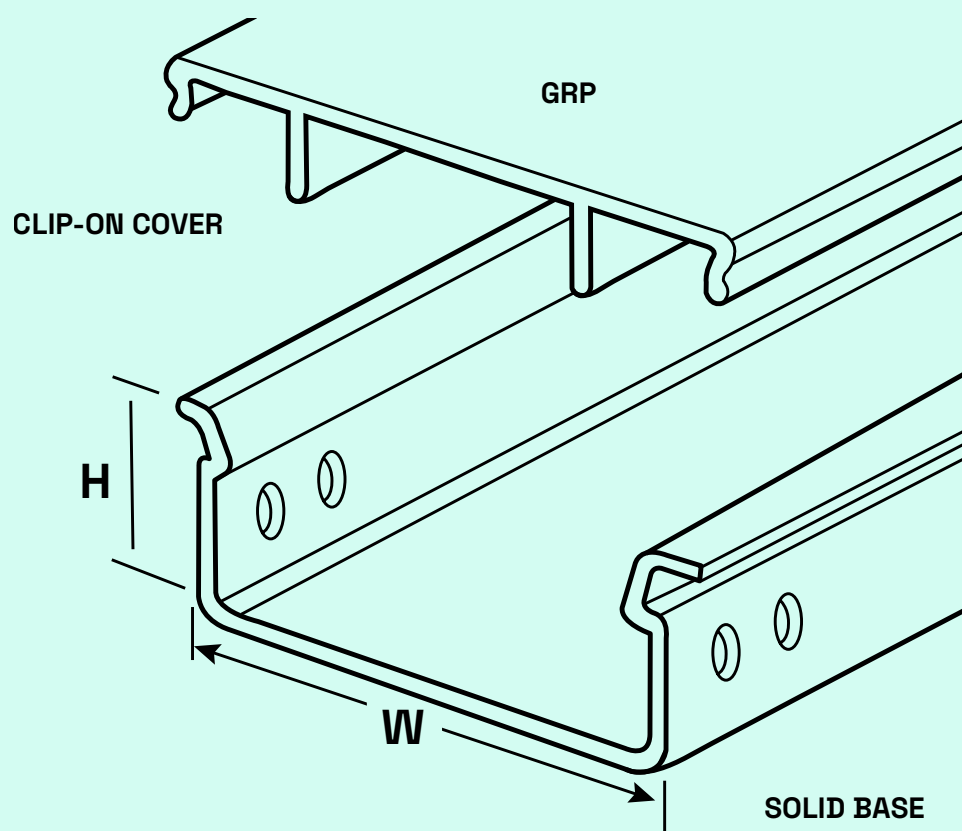

We are back. As a matter of fact, we never left.

We have been supporting our customers through their technical journey on choosing the right product in cable support applications for almost 100 years now. We cannot hide our enthusiasm having the 50 year young legend, **Mita**[®], back on track in the UK market. With our **Mita**[®] **GRP Cable Ladder, Tray, Troughing and Strut** ranges, we continue to lead the industry towards a sustainable future.

We are dedicated to bring the best-in-class products and services to you with the least time to market and highest competitive advantage. We now have our focus on you and are ambitious to grow together through our stand-alone presence in the UK and with our Made in UK” products which are fully compliant to the related standards.

We see a bright future where we continue to create clever uplifting solutions together. We are here, stronger than ever.

Patrick Arcidiacono

CEO

WIBE Group UK Ltd

WIBE Group International



GRP Cable Containment

Approvals



Standards

Material	Standards
PY1	BS 476 Part 7
	UL 94 - V0
	UL 94 - 5VA
	BS EN 60695-2-12:2001
MX	BS 476 Part 7
	BS 476 Part 6
	NES 713
	BS 6853 - D8.3
	BS 6853 - D8.4 Cat 1B
	BS 6853 - D8.6
	BS 6853 - Annex B2
	BS EN ISO 4589-2
	BS EN ISO 4589-3
	UL 94 V0
UL 94 5VA	
BS EN ISO 4589-2	
BS EN ISO 4589-3	
BS EN 60695-2-12:2001	

References

Wibe full reference	Wibe quick reference
Polyester Class 1	PY1
Acrylic Class 0	MX

Rail Applications

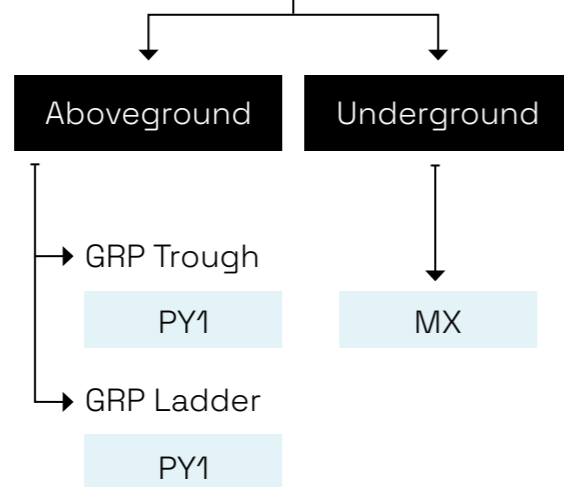

Technical guide

Mechanical Properties	Electrical Properties	Thermal Properties	Weather Resistance
Tensile Strength 20 - 30.6 kgf/mm ²	Dielectric Strength 7-15kV/mm	Thermal Conductivity 0.2 - 0.3 kcal (mh ^o C)	Water Absorption 24h = 0.15%
Compression Strength 20 - 30.6 kgf/mm ²	Insulation Resistance 3.16 x 10 ¹⁴	Oxygen Index 42%	4 days = 0.25%
Flexural Strength 20 - 30.6 kgf/mm ²		Operating Temperature -140 to + 120°C	Weight Increase After 500h = 0.7%
Shear Strength 6.1 kgf/ mm ²			
Impact Strength 60-90 kgfcm/ cm ²			
Density 1.7 - 1.9 g/ cm ³			

Note: Please see the following page for standards compliance.



Introduction

As a comprehensive manufacturer of corrosion resistant industrial cable support products, Mita – powered by Wibe group, have the solutions and expertise to specify a suitable solution, and deliver a product which can support any type of power circuit, cable, data and instrumentation.

Whether you are specifying a range of equipment for a major project or buying a selection of components for a simple maintenance installation, our premium range and support will put your mind at rest.

Wherever you are situated and whatever you need, we are committed to meeting your requirements.

Why GRP over Concrete or Steel?

- Lower cost over time
- 70% lighter than steel
- Simpler, quicker installation
- Easier modifications with no need for painting, earth bonding or special tools
- No rusting, even when exposed to salt spray, H25, acid build up from exhaust gases or brake dust
- Resistant to electromagnetic pulses and transfers heat more slowly than steel
- Completely corrosion resistant
- UV resistant
- Available in 3m or 6m lengths
- Reduced risk of staff injuries; easy to cut, lift and fit

Features

Light weight

Density and weight are significantly lower than steel (70% lighter than steel) with reduced handling requirements.

Compression strength

Despite its lower weight, tension, flexure and compression strength of GRP is almost 20 times that of steel with much greater safety factors. It does not deform permanently under high loads. Slow heat transfer allows for even stronger mechanical resistance.

Slow heat transfer and resistant to electromagnetic pulses

It is effective at temperatures between -140oC to +120oC. Resistant to electromagnetic pulses and transfers heat

more slowly than steel. Composite materials are excellent insulators having a thermal conductivity 1/60 of a steel product, and do not require earthing.

Zero halogen, UV and corrosion resistance

GRP is resistant to UV and corrosion, and is zero halogen. It is also available in low smoke classified material.

Offer and design

Available in 3m and 6m lengths. Full range of pre-manufactured bends, jointing bays and transitions available for fast installation. Dedicated design facility to support bespoke solutions.

Benefits

Health and safety

Reduced risk of staff injuries due to its lightweight, easy to cut, no hot works requirement, no deburring and no sharp edges.

Low installation and transport costs

Typically between 30-40% less than steels with easier cutting, drilling and no deburring, painting or earthing.

Long life and low maintenance

Composites are corrosion resistant and maintenance free. Our GRP products are designed and manufactured to withstand a

majority of chemicals & extreme weather – without requiring further maintenance. No rusting, even when exposed to salt spray, H25, acid build up from exhaust gases or brake dust.

Fire performance

GRP is zero halogen. It has low heat and electrical conductivity, and is available in self extinguishing and low smoke material.

Installations and modifications are simpler

Our GRP solution offers a far easier installation, without the need for painting, earth bonding or special tools. Supplying 6m or 3m lengths reduces amount of couplers required.

Applications



Rail

- Halogen free
- Slow heat transfer allows for even stronger mechanical resistance
- High safety standards; reduced risk of staff injuries
- Our flexible, simple installation means no sharp edges or burrs
- Reduced transport costs
- No earthing, deburring or painting
- Fast installation; available in 3m & 6m lengths
- Full range of pre-manufactured bends, jointing bays and transitions available for fast installation
- Dedicated design facility to support bespoke solutions

GRP Cable Containment



GRP Cable Containment Rail Solution



GRP Trough		
Size	Aboveground	Underground
100 x 110mm - Concrete C/1/6	GRP100110PY1	GRP100110MX
150 x 110mm - Concrete C/1/7	GRP150110PY1	GRP150110MX
150 x 110mm - Concrete C/1/7 - 2500V Danger sign	GRP150110KV25PY1	GRP150110KV25MX
150 x 110mm - Concrete C/1/7 - 6 meter	GRP1501106MPY1	GRP1501106MMX
150 x 110mm - Concrete C/1/7 - 2500V Danger sign 6 meter	GRP150110KV256MPY1	GRP150110KV256MMX
150 x 210mm - Concrete C/1/8	GRP150210PY1	GRP150210MX
150 x 210mm - Concrete C/1/8 - 2500V Danger sign	GRP150210KV25PY1	GRP150210KV25MX
150 x 210mm - Concrete C/1/8 - 6 meter	GRP1502106MPY1	GRP1502106MMX
150 x 210mm - Concrete C/1/8 - 2500V Danger sign - 6 meter	GRP150210KV256MPY1	GRP150210KV256MMX
200 x 110mm - Concrete C/1/9	GRP200110PY1	GRP200110MX
200 x 110mm - Concrete C/1/9 - 2500V Danger sign	GRP200110KV25PY1	GRP200110KV25MX
200 x 110mm - Concrete C/1/9 - 6 meter	GRP2001106MPY1	GRP2001106MMX
200 x 110mm - Concrete C/1/9 - 2500V Danger sign	GRP200110KV256MPY1	GRP200110KV256MMX
300 x 110mm - Concrete C/1/10	GRP300110PY1	GRP300110MX
300 x 110mm - Concrete C/1/10 - 2500V Danger sign	GRP300110KV25PY1	GRP300110KV25MX
300 x 110mm - Concrete C/1/10 - 6 meter	GRP3001106MPY1	GRP3001106MMX
300 x 110mm - Concrete C/1/10 - 2500V Danger sign 6 meter	GRP300110KV256MPY1	GRP300110KV256MMX
400 x 110mm - Concrete C/1/29	GRP400110PY1	GRP400110MX



GRP GMAX Trough		
Size	Aboveground	Underground
100 x 160 mm x 6 m	GRP1001606MPY1	GRP1001606MMX
200 x 200 mm x 6 m	GRP2002006MPY1	GRP2002006MMX



GRP Lid		
Size	Aboveground	Underground
100 x 110mm	GRC100PY1	GRC100MX
100 x 110mm - 6 meter	GRC1006PY1	GRC1006MX
150 x 110mm	GRC150PY1	GRC150MX
150 x 110mm - 2500V Danger sign	GRC150KV25PY1	GRC150KV25MX
150 x 110mm - 6 meter	GRC1506MPY1	GRC1506MMX
150 x 110mm - 2500V Danger sign - 6 meter	GRC150KV256MPY1	GRC150KV256MMX
150 x 210mm	GRC150PY1	GRC150MX
150 x 210mm - 2500V Danger sign	GRC150KV25PY1	GRC150KV25MX
150 x 210mm - 6 meter	GRC1506MPY1	GRC1506MMX
150 x 210mm - 2500V Danger sign - 6 meter	GRC150KV256MPY1	GRC150KV256MMX
200 x 110mm	GRC200PY1	GRC200MX
200 x 110mm - 2500V Danger sign	GRC200KV25PY1	GRC200KV25MX
200 x 110mm - 6 meter	GRC2006MPY1	GRC2006MMX
200 x 110mm - 2500V Danger sign - 6 meter	GRC200KV256MPY1	GRC200KV256MMX
300 x 110mm	GRC300PY1	GRC300MX
300 x 110mm - 2500V Danger sign	GRC300KV25PY1	GRC300KV25MX
300 x 110mm - 6 meter	GRC3006MPY1	GRC3006MMX
300 x 110mm - 2500V Danger sign - 6 meter	GRC300KV256MPY1	GRC300KV256MMX
400 x 110mm	GRC400PY1	GRC400MX

GRP Cable Containment Rail Solution

GRP Couplers

Size	Aboveground	Underground	Stainless Steel
100 x 110mm	GHCOPY1	GHCOSMX	GHCS
150 x 110mm	GHCOPY1	GHCOSMX	GHCS
150 x 210mm	GHC21OPY1	GHC21OSMX	GHCS210
200 x 110mm	GHCOPY1	GHCOSMX	GHCS
300 x 110mm	GHCOPY1	GHCOSMX	GHCS
400 x 110mm	GHCOPY1	GHCOSMX	GHCS

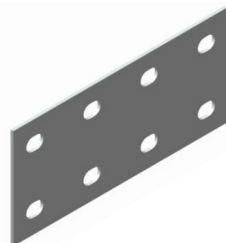

Elevated GRP Trough Adaptor - Concrete Ground Trough

Size	Aboveground	Underground
100 x 110mm - Concrete C/1/6	GRCTA1910V342BPY1	GRCTA1910V342BMX
150 x 110mm - Concrete C/1/7	GRCTA1915V342BPY1	GRCTA1915V342BMX
150 x 210mm - Concrete C/1/8	GRCTA1815OV342BPY1	GRCTA1815OV342BMX
200 x 110mm - Concrete C/1/9	GRCTA1920V342BPY1	GRCTA1920V342BMX
300 x 110mm - Concrete C/1/10	GRCTA1930V342BPY1	GRCTA1930V342BMX
400 x 110mm - Concrete C/1/29	GRCTA1940V342BPY1	GRCTA1940V342BMX

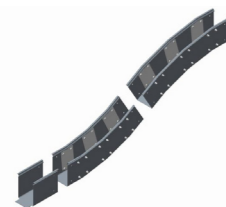

90 Degree Flat Bend

Size	Aboveground	Underground
100 x 110mm	GRA100110R1500PY1	GRA100110R1500MX
150 x 110mm	GRA150110R1500PY1	GRA150110R1500MX
150 x 210mm	GRA150210R1500PY1	GRA150210R1500MX
200 x 110mm	GRA200110R1500PY1	GRA200110R1500MX
300 x 110mm	GRA300110R1500PY1	GRA300110R1500MX
400 x 110mm	GRA400110R1500PY1	GRA400110R1500MX



90 Degree Flat Bend Lid

Size	Aboveground	Underground
100 x 110mm	GRAC100R1500PY1	GRAC100R1500MX
150 x 110mm	GRAC150R1500PY1	GRAC150R1500MX
150 x 210mm	GRAC150R1500PY1	GRAC150R1500MX
200 x 110mm	GRAC200R1500PY1	GRAC200R1500MX
300 x 110mm	GRAC300R1500PY1	GRAC300R1500MX
400 x 110mm	GRAC400R1500PY1	GRAC400R1500MX



GRP Cable Containment Rail Solution

30 Degree Flat Bend

Size	Aboveground	Underground
100 x 110mm	GRA1030110R1500PY1	GRA1030110R1500MX
150 x 110mm	GRA1530110R1500PY1	GRA1530110R1500MX
150 x 210mm	GRA1530210R1500PY1	GRA1530210R1500MX
200 x 110mm	GRA2030110R1500PY1	GRA2030110R1500MX
300 x 110mm	GRA3030110R1500PY1	GRA3030110R1500MX
400 x 110mm	GRA4030110R1500PY1	GRA4030110R1500MX



30 Degree Flat Bend Lid

Size	Aboveground	Underground
100 x 110mm	GRAC1030R1500PY1	GRAC1030R1500MX
150 x 110mm	GRAC1530R1500PY1	GRAC1530R1500MX
150 x 210mm	GRAC1530R1500PY1	GRAC1530R1500MX
200 x 110mm	GRAC2030R1500PY1	GRAC2030R1500MX
300 x 110mm	GRAC3030R1500PY1	GRAC3030R1500MX
400 x 110mm	GRAC4030R1500PY1	GRAC4030R1500MX

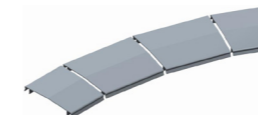

90 Degree External Riser

Size	Aboveground	Underground
100 x 110mm	GRE100110R1500PY1	GRE100110R1500MX
150 x 110mm	GRE150110R1500PY1	GRE150110R1500MX
150 x 210mm	GRE150210R1500PY1	GRE150210R1500MX
200 x 110mm	GRE200110R1500PY1	GRE200110R1500MX
300 x 110mm	GRE300110R1500PY1	GRE300110R1500MX
400 x 110mm	GRE400110R1500PY1	GRE400110R1500MX



90 Degree External Riser Lid

Size	Aboveground	Underground
100 x 110mm	GREC100110R1500PY1	GREC100110R1500MX
150 x 110mm	GREC150110R1500PY1	GREC150110R1500MX
150 x 210mm	GREC150210R1500PY1	GREC150210R1500MX
200 x 110mm	GREC200110R1500PY1	GREC200110R1500MX
300 x 110mm	GREC300110R1500PY1	GREC300110R1500MX
400 x 110mm	GREC400110R1500PY1	GREC400110R1500MX



GRP Cable Containment Rail Solution

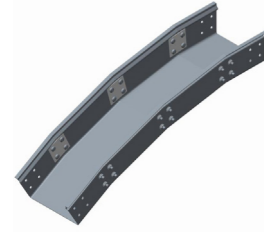

30 Degree External Riser		
Size	Aboveground	Underground
100 x 110mm	GRE1030110R1500PY1	GRE1030110R1500MX
150 x 110mm	GRE1530110R1500PY1	GRE1530110R1500MX
150 x 210mm	GRE1530210R1500PY1	GRE1530210R1500MX
200 x 110mm	GRE2030110R1500PY1	GRE2030110R1500MX
300 x 110mm	GRE3030110R1500PY1	GRE3030110R1500MX
400 x 110mm	GRE4030110R1500PY1	GRE4030110R1500MX



30 Degree External Riser Lid		
Size	Aboveground	Underground
100 x 110mm	GREC1030110R1500P1	GREC1030110R1500MX
150 x 110mm	GREC1530110R1500P1	GREC1530110R1500MX
150 x 210mm	GREC1530210R1500P1	GREC1530210R1500MX
200 x 110mm	GREC2030110R1500P1	GREC2030110R1500MX
300 x 110mm	GREC3030110R1500P1	GREC3030110R1500MX
400 x 110mm	GREC4030110R1500P1	GREC4030110R1500MX



90 Degree Internal Riser		
Size	Aboveground	Underground
100 x 110mm	GRI100110R1500PY1	GRI100110R1500MX
150 x 110mm	GRI150110R1500PY1	GRI150110R1500MX
150 x 210mm	GRI150210R1500PY1	GRI150210R1500MX
200 x 110mm	GRI200110R1500PY1	GRI200110R1500MX
300 x 110mm	GRI300110R1500PY1	GRI300110R1500MX
400 x 110mm	GRI400110R1500PY1	GRI400110R1500MX

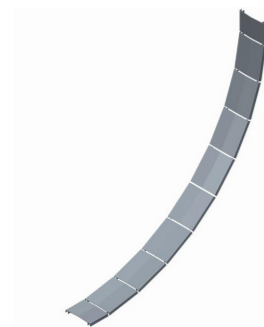

90 Degree Internal Riser Lid		
Size	Aboveground	Underground
100 x 110mm	GRIC100110R1500P1	GRIC100110R1500MX
150 x 110mm	GRIC150110R1500P1	GRIC150110R1500MX
150 x 210mm	GRIC150210R1500P1	GRIC150210R1500MX
200 x 110mm	GRIC200110R1500P1	GRIC200110R1500MX
300 x 110mm	GRIC300110R1500P1	GRIC300110R1500MX
400 x 110mm	GRIC400110R1500P1	GRIC400110R1500MX

GRP Cable Containment Rail Solution

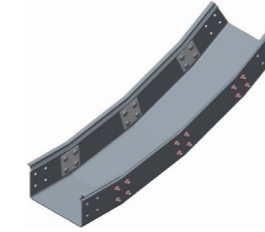

30 Degree Internal Riser		
Size	Aboveground	Underground
100 x 110mm	GRI1030110R1500PY1	GRI1030110R1500MX
150 x 110mm	GRI1530110R1500PY1	GRI1530110R1500MX
150 x 210mm	GRI1530210R1500PY1	GRI1530210R1500MX
200 x 110mm	GRI2030110R1500PY1	GRI2030110R1500MX
300 x 110mm	GRI3030110R1500PY1	GRI3030110R1500MX
400 x 110mm	GRI4030110R1500PY1	GRI4030110R1500MX



30 Degree Internal Riser Lid		
Size	Aboveground	Underground
100 x 110mm	GRIC1030110R1500P1	GRIC1030110R1500MX
150 x 110mm	GRIC1530110R1500P1	GRIC1530110R1500MX
150 x 210mm	GRIC1530210R1500P1	GRIC1530210R1500MX
200 x 110mm	GRIC2030110R1500P1	GRIC2030110R1500MX
300 x 110mm	GRIC3030110R1500P1	GRIC3030110R1500MX
400 x 110mm	GRIC4030110R1500P1	GRIC4030110R1500MX

GRP Trough Reducers



GRP Trough Reducers

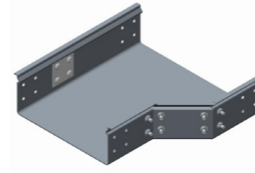

Left Hand Reducer

Size	Aboveground		Underground	
150x110mm to 100x110mm	GR150L10110PY1	GRC150L10PY1	GR150L10110MX	GRC150L10MX
200x110mm to 150x110mm	GR200L15110PY1	GRC200L15PY1	GR200L15110MX	GRC200L15MX
200x110mm to 150x210mm	GR200110L150210PY1	*Supplied with Lid	GR200110L150210MX	*Supplied with Lid
300x110mm to 200x110mm	GR300L20110PY1	GRC300L20PY1	GR300L20110MX	GRC300L20MX
400x110mm to 300x110mm	GR400L30110PY1	GRC400L30PY1	GR400L30110MX	GRC400L30MX

* GRP trough reducer and lid supplied together

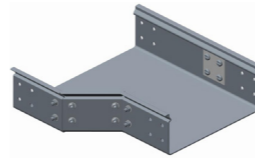

Right Hand Reducer

Size	Aboveground		Underground	
150x110mm to 100x110mm	GR150R10110PY1	GRC150R10PY1	GR150R10110MX	GRC150R10MX
200x110mm to 150x110mm	GR200R15110PY1	GRC200R15PY1	GR200R15110MX	GRC200R15MX
200x110mm to 150x210mm	GR200110R150210PY1	*Supplied with Lid	GR200110R150210MX	*Supplied with Lid
300x110mm to 200x110mm	GR300R20110PY1	GRC300R20PY1	GR300R20110MX	GRC300R20MX
400x110mm to 300x110mm	GR400R30110PY1	GRC400R30PY1	GR400R30110MX	GRC400R30MX

* GRP trough reducer and lid supplied together

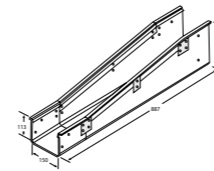

Base Level Straight Reducer

Size	Aboveground	Underground
150x110 to 150x210	GR15211511BCPY1	GR15211511BCMx

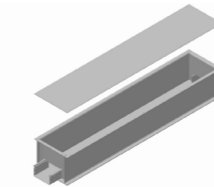

GRP Trough Jointing Bay

GRP I beam post length	Aboveground	Underground
350W x 300D x 200 x 110 Trough	GRPJBAY200110C43P1	GRPJBAY200110C43MX

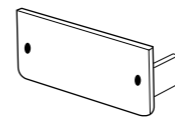

GRP Trough End Stops

Size	Aboveground	Underground
100x110	END100110PY1	END100110MX
150x110	END150110PY1	END150110MX
150x210	END150210PY1	END150210MX
200x110	END200110PY1	END200110MX
300x110	END300110PY1	END300110MX
400x110	END400110PY1	END400110MX

GRP Fixings



NEW



NEW



Panhead Bolts, Nuts & Washers

Reference number	Specification
MSS820BP	Bolt M8 x 20mm Slotted panhead 316 stainless steel
MSS8N	Nut M8 316 Stainless Steel
W8SS	Washer round M8 316 stainless steel

Bracket to Post Fixing Kit

Reference number	Specification
M8BNWZP/B	M8 Nut, Bolt washer kit hot dip galv.

Steel Brackets for GRP Posts

Reference number	Dimensions	For use with trough width
BRK150SL50	230 x 150 x 50mm	100mm
BRK200SL50	230 x 200 x 50mm	150mm
BRK250SL50	230 x 250 x 50mm	200mm

Steel Brackets for Steel Posts or Walls

Reference number	Dimensions	For troughing size
BRK150	230 x 150 x 110	GRP100
BRK200	230 x 200 x 110	GRP150
BRK250	230 x 250 x 110	GRP200
BRK350	230 x 350 x 110	GRP300
BRK450	230 x 450 x 110	GRP400

Steel Brackets and Trough Leveling Accessories for GRP GMAX Posts

Reference number	Description	For troughing size
RB1006M + PM100 + CB100	Riser bracket, post mounting and cantilever kit	GRP100 GRP GMAX
RB2006M + PM200 + CB200	Riser bracket, post mounting and cantilever kit	GRP200 GRP GMAX
HDCS	Holddown clamp	GRP GMAX

Elevated Trough Posts GRP

GRP Posts for trough size 100mm - 200mm wide	GRP I beam post length
MPG14PY1	1.4 metres
MPG20PY1	2.0 metres
MPG24PY1	2.4 metres
MPG30PY1	3.0 metres

GRP Posts for trough size 100mm-200mm wide for GRP GMAX	GRP I beam post length
MPG20L6MPY1	2.0 meters
MPG24h6MPY1	2.4 meters
MPG30h6MPY1	3.0 meters

Elevated Trough Post Steel

GRP Posts for trough size 300mm - 400mm wide	Specification
MPS14	Single trough, Steel hot dip galv. 1.4 metres
MPD14	Double trough, Steel hot dip galv. 1.4 metres
MPS24	Single trough, Steel hot dip galv. 2.4 metres
MPD24	Double trough, Steel hot dip galv. 2.4 metres
MPS30	Single trough, steel hot dip galv 3 metres
MPD30	Double trough, Steel hot dip galv 3 metres

Cleats

Heavy Duty Cleats

Ref	Description	Pack Quantity	Weight (kg)	Length (mm)	Width (mm)	Height (mm)
Single Hole Cleats						
CL1F10B	Cleat Single Hole 10 to 13mm	100	0,02	41,4	37,8	30
CL1F11B	Cleat Single Hole 13 to 16mm	100	0,03	41,4	41,2	33
CL1F12B	Cleat Single Hole 16 to 19mm	100	0,03	41,4	44,3	36
CL1F13B	Cleat Single Hole 19 to 23mm	100	0,04	41,4	48,2	40
CL1F14B	Cleat Single Hole 23 to 27mm	100	0,04	41,4	52,2	44
CL1F15B	Cleat Single Hole 27 to 32mm	100	0,05	41,4	57,1	49
CL1F16B	Cleat Single Hole 32 to 38mm	100	0,06	41,4	63,1	55
CL1F17B	Cleat Single Hole 38 to 46mm	50	0,08	41,4	71,3	66
CL1F18B	Cleat Single Hole 46 to 51mm	50	0,09	41,4	77,3	73
CL1F19B	Cleat Single Hole 51 to 57mm	50	0,1	41,4	83,2	78
Two Hole Cleats						
CL2F10B	Cleat 2-Hole 57 to 64mm	25	0,09	54	103	89
CL2F11LB	Cleat 2-Hole 64 to 70mm	10	0,12	54	130	95
CL2F1200B	Cleat 2-Hole 70 to 76mm	10	0,16	75	128	101
CL2F1201B	Cleat 2-Hole 76 to 83mm	10	0,17	75	135	107
CL2F1202B	Cleat 2-Hole 83 to 90mm	10	0,19	75	143	115
CL2F132B	Cleat 2-Hole 97 to 105mm	5	0,36	100	171	130
CL2F141LB	Cleat 2-Hole 105 to 112mm	5	0,38	100	178	137
Approved by London Underground						
CL1F10LUL	Cleat LUL 10 to 13mm	100	0,02	41,4	37,8	30
CL1F11LUL	Cleat LUL 13 to 16mm	100	0,03	41,4	41,2	33
CL1F12LUL	Cleat LUL 16 to 19mm	100	0,03	41,4	44,3	36
CL1F13LUL	Cleat LUL 19 to 23mm	100	0,04	41,4	48,2	40
CL1F14LUL	Cleat LUL 23 to 27mm	100	0,04	41,4	52,2	44
CL1F15LUL	Cleat LUL 27 to 32mm	100	0,05	41,4	57,1	49
CL1F16LUL	Cleat LUL 32 to 38mm	100	0,06	41,4	63,1	55
CL1F17LUL	Cleat LUL 38 to 46mm	50	0,08	41,4	71,3	66
CL1F18LUL	Cleat LUL 46 to 51mm	50	0,09	41,4	77,3	73
CL1F19LUL	Cleat LUL 51 to 57mm	50	0,1	41,4	83,2	78
No bolt - twist fix						
CLNBC1822TF	Cleat TF 18-22mm	1	0,83	90	109	192
CLNBC2026TF	Cleat TF 20-26mm	1	0,82	90	109	192
CLNBC2430TF	Cleat TF 24-30mm	1	0,81	90	109	192
CLNBC2834TF	Cleat TF 28-34mm	1	0,8	90	109	192
CLNBC3239TF	Cleat TF 32-39mm	1	0,79	90	109	192
CLNBC3747TF	Cleat TF 37-47mm	1	0,76	90	109	192
CLNBC4555TF	Cleat TF 45-55mm	1	0,68	85	109	192

Ladder

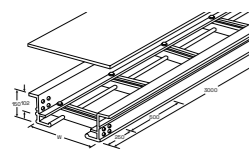

GXL Ladder						
Size			Aboveground		Underground	
W (mm)	D (mm)	L (mm)	Reference	Cover Reference	Reference	Cover Reference
150	150	3000	GXL150PY1	GZL150PY1	GXL150MX	GZL150MX
200	150	3000	GXL200PY1	GZL200PY1	GXL200MX	GZL200MX
300	150	3000	GXL300PY1	GZL300PY1	GXL300MX	GZL300MX
400	150	3000	GXL400PY1	GZL400PY1	GXL400MX	GZL400MX
450	150	3000	GXL450PY1	GZL450PY1	GXL450MX	GZL450MX
600	150	3000	GXL600PY1	GZL600PY1	GXL600MX	GZL600MX
750	150	3000	GXL750PY1	GZL750PY1	GXL750MX	GZL750MX
900	150	3000	GXL900PY1	GZL900PY1	GXL900MX	GZL900MX
1000	150	3000	GXL1000PY1	GZL1000PY1	GXL1000MX	GZL1000MX

Reducers

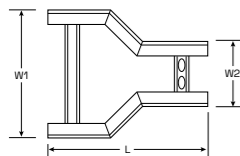

Reducer Straight						
Size			Aboveground		Underground	
W1 (mm)	W2 (mm)	L (mm)	Reference	Cover Reference	Reference	Cover Reference
300	150	478	GXR3015PY1	GZR3015PY1	GXR3015MX	GZR3015MX
400	150	524	GXR4015PY1	GZR4015PY1	GXR4015MX	GZR4015MX
400	300	453	GXR4030PY1	GZR4030PY1	GXR4030MX	GZR4030MX
450	300	478	GXR4530PY1	GZR4530PY1	GXR4530MX	GZR4530MX
600	300	553	GXR6030PY1	GZR6030PY1	GXR6030MX	GZR6030MX
600	450	478	GXR6045PY1	GZR6045PY1	GXR6045MX	GZR6045MX
750	600	478	GXR7560PY1	GZR7560PY1	GXR7560MX	GZR7560MX
900	750	478	GXR9075PY1	GZR9075PY1	GXR9075MX	GZR9075MX
1000	750	524	GXR1075PY1	GZR1075PY1	GXR1075MX	GZR1075MX

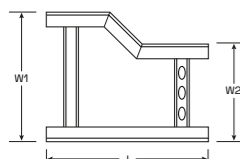

Reducer L/Hand						
Size			Aboveground		Underground	
W1 (mm)	W2 (mm)	L (mm)	Reference	Cover Reference	Reference	Cover Reference
300	150	553	GXRL3015PY1	GZRL3015PY1	GXRL3015MX	GZRL3015MX
400	150	653	GXRL4015PY1	GZRL4015PY1	GXRL4015MX	GZRL4015MX
400	300	503	GXRL4030PY1	GZRL4030PY1	GXRL4030MX	GZRL4030MX
450	300	553	GXRL4530PY1	GZRL4530PY1	GXRL4530MX	GZRL4530MX
600	300	703	GXRL6030PY1	GZRL6030PY1	GXRL6030MX	GZRL6030MX
600	450	553	GXRL6045PY1	GZRL6045PY1	GXRL6045MX	GZRL6045MX
750	600	553	GXRL7560PY1	GZRL7560PY1	GXRL7560MX	GZRL7560MX
900	750	553	GXRL9075PY1	GZRL9075PY1	GXRL9075MX	GZRL9075MX
1000	750	653	GXRL1075PY1	GZRL1075PY1	GXRL1075MX	GZRL1075MX

Reducers continued

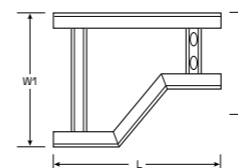

Reducer R/Hand						
Size			Aboveground		Underground	
W1 (mm)	W2 (mm)	L (mm)	Reference	Cover Reference	Reference	Cover Reference
300	150	553	GXRR3015PY1	GZRR3015PY1	GXRR3015MX	GZRR3015MX
400	150	653	GXRR4015PY1	GZRR4015PY1	GXRR4015MX	GZRR4015MX
400	300	503	GXRR4030PY1	GZRR4030PY1	GXRR4030MX	GZRR4030MX
450	300	553	GXRR4530PY1	GZRR4530PY1	GXRR4530MX	GZRR4530MX
600	300	703	GXRR6030PY1	GZRR6030PY1	GXRR6030MX	GZRR6030MX
600	450	553	GXRR6045PY1	GZRR6045PY1	GXRR6045MX	GZRR6045MX
750	600	553	GXRR7560PY1	GZRR7560PY1	GXRR7560MX	GZRR7560MX
900	750	553	GXRR9075PY1	GZRR9075PY1	GXRR9075MX	GZRR9075MX
1000	750	653	GXRR1075PY1	GZRR1075PY1	GXRR1075MX	GZRR1075MX

Bends

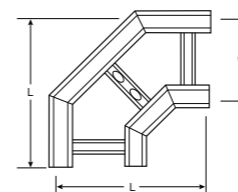

90° Flat Bend Radius 1500					
Size		Aboveground		Underground	
W1 (mm)	L (mm)	Reference	Cover Reference	Reference	Cover Reference
150	1660	GXA150R1500PY1	GZA150R1500PY1	GXA150R1500MX	GZA150R1500MX
200	1710	GXA200R1500PY1	GZA200R1500PY1	GXA200R1500MX	GZA200R1500MX
300	1810	GXA300R1500PY1	GZA300R1500PY1	GXA300R1500MX	GZA300R1500MX
400	1910	GXA400R1500PY1	GZA400R1500PY1	GXA400R1500MX	GZA400R1500MX
450	1960	GXA450R1500PY1	GZA450R1500PY1	GXA450R1500MX	GZA450R1500MX
600	2110	GXA600R1500PY1	GZA600R1500PY1	GXA600R1500MX	GZA600R1500MX
750	2260	GXA750R1500PY1	GZA750R1500PY1	GXA750R1500MX	GZA750R1500MX
900	2410	GXA900R1500PY1	GZA900R1500PY1	GXA900R1500MX	GZA900R1500MX
1000	2510	GXA1000R1500PY1	GZA1000R1500PY1	GXA1000R1500MX	GZA1000R1500MX

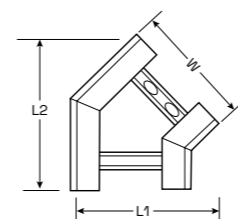

45° Flat Bend Radius 1500						
Size		Aboveground		Underground		
W (mm)	L1 (mm)	L2 (mm)	Reference	Cover Reference	Reference	Cover Reference
150	1260	670	GXA1545R1500PY1	GZA1545R1500PY1	GXA1545R1500MX	GZA1545R1500MX
200	1300	720	GXA2045R1500PY1	GZA2045R1500PY1	GXA2045R1500MX	GZA2045R1500MX
300	1370	820	GXA3045R1500PY1	GZA3045R1500PY1	GXA3045R1500MX	GZA3045R1500MX
400	1440	920	GXA4045R1500PY1	GZA4045R1500PY1	GXA4045R1500MX	GZA4045R1500MX
450	1480	970	GXA4545R1500PY1	GZA4545R1500PY1	GXA4545R1500MX	GZA4545R1500MX
600	1580	1120	GXA6045R1500PY1	GZA6045R1500PY1	GXA6045R1500MX	GZA6045R1500MX
750	1690	1270	GXA7545R1500PY1	GZA7545R1500PY1	GXA7545R1500MX	GZA7545R1500MX
900	1790	1420	GXA9045R1500PY1	GZA9045R1500PY1	GXA9045R1500MX	GZA9045R1500MX
1000	1860	1520	GXA1045R1500PY1	GZA1045R1500PY1	GXA1045R1500MX	GZA1045R1500MX

Risers

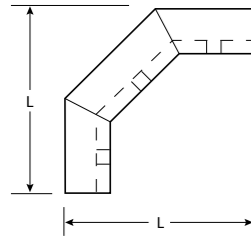

External 90° Riser Radius 1500					
Size		Aboveground		Underground	
W (mm)	L (mm)	Reference	Cover Reference	Reference	Cover Reference
150	1560	GXE150R1500PY1	GZE150R1500PY1	GXE150R1500MX	GZE150R1500MX
200	1560	GXE200R1500PY1	GZE200R1500PY1	GXE200R1500MX	GZE200R1500MX
300	1560	GXE300R1500PY1	GZE300R1500PY1	GXE300R1500MX	GZE300R1500MX
400	1560	GXE400R1500PY1	GZE400R1500PY1	GXE400R1500MX	GZE400R1500MX
450	1560	GXE450R1500PY1	GZE450R1500PY1	GXE450R1500MX	GZE450R1500MX
600	1560	GXE600R1500PY1	GZE600R1500PY1	GXE600R1500MX	GZE600R1500MX
750	1560	GXE750R1500PY1	GZE750R1500PY1	GXE750R1500MX	GZE750R1500MX
900	1560	GXE900R1500PY1	GZE900R1500PY1	GXE900R1500MX	GZE900R1500MX
1000	1560	GXE1000R1500PY1	GZE1000R1500PY1	GXE1000R1500MX	GZE1000R1500MX

Internal 90° Riser Radius 1500					
Size		Aboveground		Underground	
W (mm)	L (mm)	Reference	Cover Reference	Reference	Cover Reference
150	1460	GXI150R1500PY1	GZI150R1500PY1	GXI150R1500MX	GZI150R1500MX
200	1460	GXI200R1500PY1	GZI200R1500PY1	GXI200R1500MX	GZI200R1500MX
300	1460	GXI300R1500PY1	GZI300R1500PY1	GXI300R1500MX	GZI300R1500MX
400	1460	GXI400R1500PY1	GZI400R1500PY1	GXI400R1500MX	GZI400R1500MX
450	1460	GXI450R1500PY1	GZI450R1500PY1	GXI450R1500MX	GZI450R1500MX
600	1460	GXI600R1500PY1	GZI600R1500PY1	GXI600R1500MX	GZI600R1500MX
750	1460	GXI750R1500PY1	GZI750R1500PY1	GXI750R1500MX	GZI750R1500MX
900	1460	GXI900R1500PY1	GZI900R1500PY1	GXI900R1500MX	GZI900R1500MX
1000	1460	GXI1000R1500PY1	GZI1000R1500PY1	GXI1000R1500MX	GZI1000R1500MX

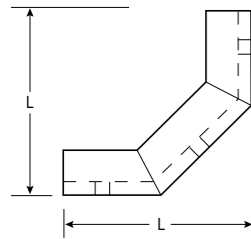

External 45° Riser Radius 1500						
Size		Aboveground		Underground		
W1 (mm)	L1 (mm)	L2 (mm)	Reference	Cover Reference	Reference	Cover Reference
150	620	1230	GXE1545R1500PY1	GZE1545R1500PY1	GXE1545R1500MX	GZE1545R1500MX
200	620	1230	GXE2045R1500PY1	GZE2045R1500PY1	GXE2045R1500MX	GZE2045R1500MX
300	620	1230	GXE3045R1500PY1	GZE3045R1500PY1	GXE3045R1500MX	GZE3045R1500MX
400	620	1230	GXE4045R1500PY1	GZE4045R1500PY1	GXE4045R1500MX	GZE4045R1500MX
450	620	1230	GXE4545R1500PY1	GZE4545R1500PY1	GXE4545R1500MX	GZE4545R1500MX
600	620	1230	GXE6045R1500PY1	GZE6045R1500PY1	GXE6045R1500MX	GZE6045R1500MX
750	620	1230	GXE7545R1500PY1	GZE7545R1500PY1	GXE7545R1500MX	GZE7545R1500MX
900	620	1230	GXE9045R1500PY1	GZE9045R1500PY1	GXE9045R1500MX	GZE9045R1500MX
1000	620	1230	GXE1045R1500PY1	GZE1045R1500PY1	GXE1045R1500MX	GZE1045R1500MX

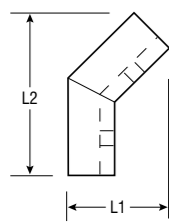

Risers

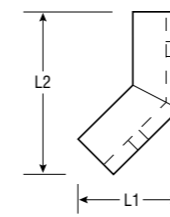

Internal 45° Riser Radius 1500						
Size		Aboveground		Underground		
W1 (mm)	L1 (mm)	L2 (mm)	Reference	Cover Reference	Reference	Cover Reference
150	570	1120	GXI1545R1500PY1	GZI1545R1500PY1	GXI1545R1500MX	GZI1545R1500MX
200	570	1120	GXI2045R1500PY1	GZI2045R1500PY1	GXI2045R1500MX	GZI2045R1500MX
300	570	1120	GXI3045R1500PY1	GZI3045R1500PY1	GXI3045R1500MX	GZI3045R1500MX
400	570	1120	GXI4045R1500PY1	GZI4045R1500PY1	GXI4045R1500MX	GZI4045R1500MX
450	570	1120	GXI4545R1500PY1	GZI4545R1500PY1	GXI4545R1500MX	GZI4545R1500MX
600	570	1120	GXI6045R1500PY1	GZI6045R1500PY1	GXI6045R1500MX	GZI6045R1500MX
750	570	1120	GXI7545R1500PY1	GZI7545R1500PY1	GXI7545R1500MX	GZI7545R1500MX
900	570	1120	GXI9045R1500PY1	GZI9045R1500PY1	GXI9045R1500MX	GZI9045R1500MX

Tees & Crossovers

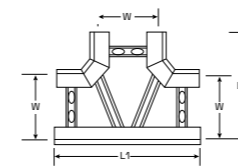

rung configuration will change with width

Equal Tee Radius 1500						
Size		Aboveground		Underground		
W (mm)	L1 (mm)	L2 (mm)	Reference	Cover Reference	Reference	Cover Reference
150	2290	1220	GXT150R1500PY1	GZT150R1500PY1	GXT150R1500MX	GZT150R1500MX
200	2340	1270	GXT200R1500PY1	GZT200R1500PY1	GXT200R1500MX	GZT200R1500MX
300	2440	1370	GXT300R1500PY1	GZT300R1500PY1	GXT300R1500MX	GZT300R1500MX
400	2540	1470	GXT400R1500PY1	GZT400R1500PY1	GXT400R1500MX	GZT400R1500MX
450	2590	1520	GXT450R1500PY1	GZT450R1500PY1	GXT450R1500MX	GZT450R1500MX
600	2740	1670	GXT600R1500PY1	GZT600R1500PY1	GXT600R1500MX	GZT600R1500MX
750	2890	1820	GXT750R1500PY1	GZT750R1500PY1	GXT750R1500MX	GZT750R1500MX
900	3040	1970	GXT900R1500PY1	GZT900R1500PY1	GXT900R1500MX	GZT900R1500MX
1000	3140	2070	GXT1000R1500PY1	GZT1000R1500PY1	GXT1000R1500MX	GZT1000R1500MX

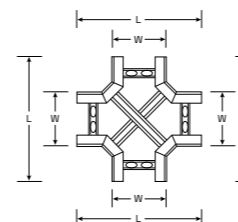

rung configuration will change with width

Equal Cross Radius 1500					
Size		Aboveground		Underground	
W (mm)	L (mm)	Reference	Cover Reference	Reference	Cover Reference
150	2290	GXX150R1500PY1	GZX150R1500PY1	GXX150R1500MX	GZX150R1500MX
200	2340	GXX200R1500PY1	GZX200R1500PY1	GXX200R1500MX	GZX200R1500MX
300	2440	GXX300R1500PY1	GZX300R1500PY1	GXX300R1500MX	GZX300R1500MX
400	2540	GXX400R1500PY1	GZX400R1500PY1	GXX400R1500MX	GZX400R1500MX
450	2590	GXX450R1500PY1	GZX450R1500PY1	GXX450R1500MX	GZX450R1500MX
600	2740	GXX600R1500PY1	GZX600R1500PY1	GXX600R1500MX	GZX600R1500MX
750	2890	GXX750R1500PY1	GZX750R1500PY1	GXX750R1500MX	GZX750R1500MX
900	3040	GXX900R1500PY1	GZX900R1500PY1	GXX900R1500MX	GZX900R1500MX
1000	3140	GXX1000R1500PY1	GZX1000R1500PY1	GXX1000R1500MX	GZX1000R1500MX

Additional Ladder Depth for GXL Ladder	
Aboveground	Underground
GMLNSIDEPY1	GMLNSIDEMX

GMLN ladder siderail - GMLNSIDE

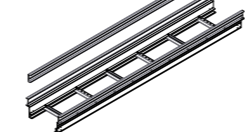

GXL Ladder with GMLN side Rail Fitted to top

GRP Ladders



GRP Ladders

GRP Ladder - Coupler Table





	Material	Profile: GXL - H = 69mm
 <p>Straight Coupler</p>	SS	GHCS
 <p>Vertical Hinged Coupler Max Ext Angle = 45° Max Int Angle = 90°</p>	SS	GVHCS
 <p>Variable Angle Coupler</p>	SS	GHCS
 <p>Ladder Clamp Use M10 size fastener</p>	SS	GHDCS
 <p>Fixed Support</p>	GRP	GFES
 <p>Hinged End Fixing</p>	GRP	GHEF

Drawings are for illustration purposes only and may vary depending on the profile selected.
 Hole diameter on all items is M8 clearance with the exception of GHDC which has M10 clearance.
 SS = Stainless Steel
 GRP = Glass Reinforced Plastic

End Caps

Ref	Ladder Width (mm)
ENDGXL150MX	150
ENDGXL200MX	200
ENDGXL300MX	300
ENDGXL400MX	400
ENDGXL450MX	450
ENDGXL600MX	600
ENDGXL750MX	750
ENDGXL900MX	900
ENDGXL1000MX	1000

Fastener Selection Chart

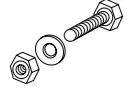
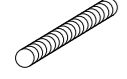
SS316 Ladder Systems					
	Material	Length mm	Thread Size & Reference Numbers		Remarks
			M8	M12	
	Hexagonal Nut	SS316	MSS8N	MSS10N	For all applications
	Round Washer	SS316	W8SS	W10SS	
	Crinkle Washer	SS316	SCW8S	SCW10S	For higher security applications
	Hexagonal Bolt	SS316	20	MSS8B	
	Pan Head Bolts	SS316	20	MSS820BP	
	Hex Bolt, Nut & Washer	SS316	20	MSS8	Except washer No washer required for Grylon
	Screwed Rod	SS316	1m	SSR10100	In Stainless Steel for heavy duty
			3m	SSR10300	

